



MASTER INSTRUMENT CORPORATION

SINGLE-PHASE BRIDGE RECTIFIER
2W005M THRU 2W10M
RC201 THRU RC207

VOLTAGE RANGE 50 to 1000 Volts
CURRENT 1.5 Amperes

FEATURES

- l Low cost
- l This series is UL recognized under component index, file number E127707
- l High forward surge current capability
- l Ideal for printed circuit board
- l High temperature soldering guaranteed: 260°C/10 second, 0.375"(9.5mm) lead length at 5 lbs. (2.3kg) tension.

MECHANICAL DATA

- l Case: Molded plastic body
- l Terminal: Lead solderable per MIL-STD-202E method 208C.
- l Polarity: Polarity symbols molded on case
- l Mounting position: Any
- l Weight: 0.05ounce, 1.42grams

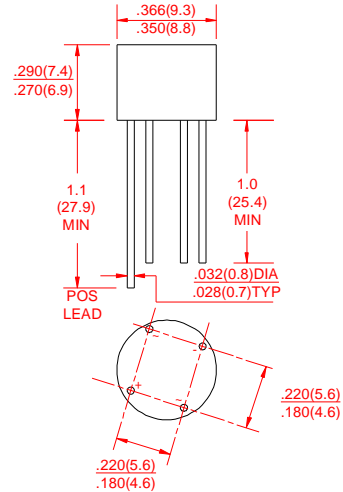

Dimensions in inches and (millimeters)

MAXIMUM RATINGS AND ELECTRICAL CHARACTERISTICS

Ratings at 25°C ambient temperature unless otherwise specified.
 Single phase, half wave, 60Hz, resistive or inductive load.
 For capacitive load derate current by 20%.

	SYMBOLS	2W005M RC201	2W01M RC202	2W02M RC203	2W04M RC204	2W06M RC205	2W08M RC206	2W10M RC207	UNITS
Maximum Repetitive Peak Reverse Voltage	V_{RRM}	50	100	200	400	600	800	1000	Volts
Maximum RMS Voltage	V_{RMS}	35	70	140	280	420	560	700	Volts
Maximum DC Blocking Voltage	V_{DC}	50	100	200	400	600	800	1000	Volts
Maximum Average Forward Rectified Output Current, at $T_A=25^\circ\text{C}$	$I_{(AV)}$	1.5							Amps
Peak Forward Surge Current 8.3ms single half sine-wave superimposed on rated load (JEDEC Method)	I_{FSM}	50							Amps
Rating for Fusing($t < 8.3\text{ms}$)	I^2T	10							A^2S
Maximum Instantaneous Forward Voltage at 1.0A	V_F	1.0							Volts
Maximum DC Reverse Current at rated DC blocking voltage	$T_A=25^\circ\text{C}$	5.0							μAmps
	$T_A=100^\circ\text{C}$	0.5							mAmps
Typical Junction Capacitance(Note1)	C_J	15							pF
Typical Thermal Resistance(Note2)	$R_{\theta JA}$	40							$^\circ\text{C/W}$
Operating Temperature Range	T_J	-55 to +150							$^\circ\text{C}$
Storage Temperature Range	T_{STG}	-55 to +150							$^\circ\text{C}$

NOTES:

1. Measured at 1.0MHz and applied reverse voltage of 4.0 volts.
2. Unit mounted on P.C. board with $0.22" \times 0.22"$ ($5.5 \times 5.5\text{mm}$) copper pads, 0.375"(9.5mm) lead length.



MASTER INSTRUMENT CORPORATION

SINGLE-PHASE BRIDGE RECTIFIER
2W005M THRU 2W10M
RC201 THRU RC207

VOLTAGE RANGE 50 to 1000 Volts
CURRENT 1.5 Amperes

RATINGS AND CHARACTERISTIC CURVES 2W005M THRU 2W10M

FIG.1-DERATING CURVE FOR OUTPUT RECTIFIED CURRENT

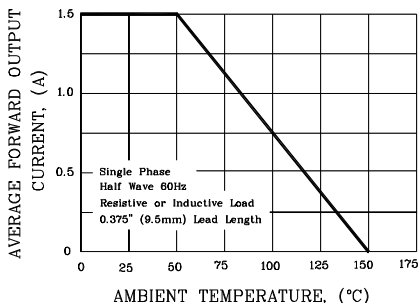

FIG.2-MAXIMUM NON-REPETITIVE PEAK FORWARD SURGE CURRENT PER ELEMENT

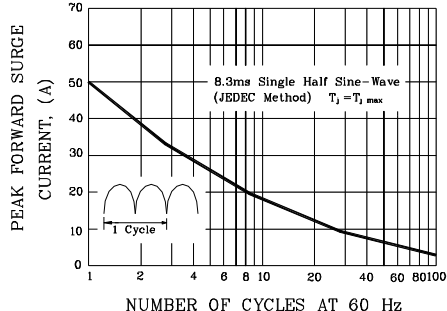

FIG.3-TYPICAL FORWARD CHARACTERISTICS PER BRIDGE ELEMENT

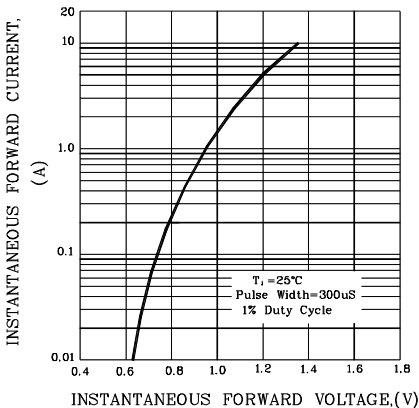

FIG.4-TYPICAL REVERSE CHARACTERISTICS PER BRIDGE ELEMENT

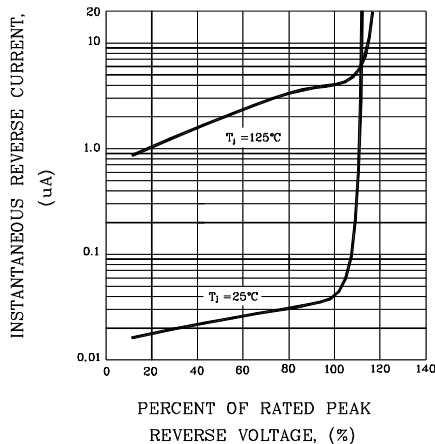

FIG.5-TYPICAL JUNCTION CAPACITANCE PER BRIDGE ELEMENT

