

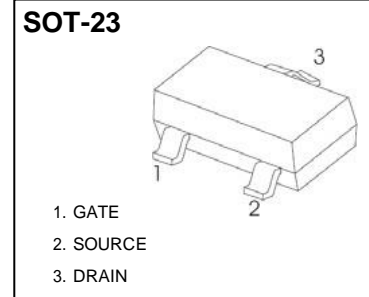

## SOT-23 Plastic-Encapsulate MOSFETS

### BSS123 N Channel MOSFET

$V_{(BR)DSS}$	$R_{DS(on)MAX}$	$I_D$
100V	6Ω@10V	0.17A
	10Ω@4.5V	



#### FEATURE

- Surface Mount Package
- High Density Cell Design for Extremely Low  $R_{DS(ON)}$
- Voltage Controlled Small Signal Switch
- Rugged and Reliable

#### APPLICATION

- Small Servo Motor Controls
- Power MOSFET Gate Drivers
- Switching Application

#### MARKING

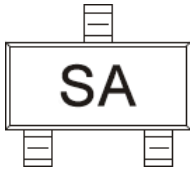

#### Equivalent Circuit

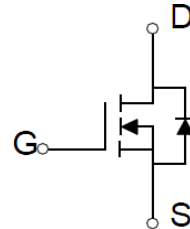

#### ABSOLUTE MAXIMUM RATINGS ( $T_a=25^{\circ}C$ unless otherwise noted)

Parameter	Symbol	Value	Unit
<b>N-MOSFET</b>			
Drain-Source Voltage	$V_{DS}$	100	V
Gate-Source Voltage	$V_{GS}$	±20	V
Continuous Drain Current (note 1)	$I_D$	0.17	A
Pulsed Drain Current ( $t_p=10\mu s$ )	$I_{DM}$	0.68	A
Continuous Source-Drain Diode Current	$I_S$	0.17	A
Power Dissipation	$P_D$	0.35	W
Thermal Resistance from Junction to Ambient (note 1)	$R_{\theta JA}$	357	$^{\circ}C/W$
Junction Temperature	$T_J$	150	$^{\circ}C$
Storage Temperature	$T_{STG}$	-55~+150	$^{\circ}C$
Lead Temperature for Soldering Purposes(1/8" from case for 10 s)	$T_L$	260	$^{\circ}C$

# MOSFET ELECTRICAL CHARACTERISTICS

$T_a=25^\circ\text{C}$  unless otherwise specified

Parameter	Symbol	Test Condition	Min	Typ	Max	Unit
<b>STATIC CHARACTERISTICS</b>						
Drain-source breakdown voltage	$V_{(BR)DSS}$	$V_{GS} = 0V, I_D = 250\mu A$	100			V
Zero gate voltage drain current	$I_{DSS}$	$V_{DS} = 100V, V_{GS} = 0V$			1	$\mu A$
		$V_{DS} = 20V, V_{GS} = 0V$			10	nA
Gate-body leakage current	$I_{GSS}$	$V_{GS} = \pm 20V, V_{DS} = 0V$			$\pm 50$	nA
Gate threshold voltage (note 2)	$V_{GS(th)}$	$V_{DS} = V_{GS}, I_D = 250\mu A$	1		2.8	V
Drain-source on-resistance(note 2)	$R_{DS(on)}$	$V_{GS} = 4.5V, I_D = 0.17A$			10	$\Omega$
		$V_{GS} = 10V, I_D = 0.17A$			6	$\Omega$
Forward tranconductance(note 2)	$g_{FS}$	$V_{DS} = 10V, I_D = 170mA$	80			mS
Diode forward voltage	$V_{SD}$	$I_S = 340mA, V_{GS} = 0V$			1.3	V
<b>DYNAMIC CHARACTERISTICS (note 4)</b>						
Input Capacitance	$C_{iss}$	$V_{DS} = 25V, V_{GS} = 0V, f = 1MHz$		29	60	pF
Output Capacitance	$C_{oss}$			10	15	pF
Reverse Transfer Capacitance	$C_{rss}$			2	6	pF
<b>SWITCHING CHARACTERISTICS (note 3,4)</b>						
Turn-on delay time	$t_{d(on)}$	$V_{GS} = 10V, V_{DD} = 30V, I_D = 2.8A, R_{GEN} = 50\Omega$			8	ns
Turn-on rise time	$t_r$				8	ns
Turn-off delay time	$t_{d(off)}$				13	ns
Turn-off fall time	$t_f$				16	ns
Total Gate Charge	$Q_g$	$V_{DS} = 10V, I_D = 0.22A, V_{GS} = 10V$		1.4	2	nC
Gate-Source Charge	$Q_{gs}$			0.15	0.25	nC
Gate-Drain Charge	$Q_{gd}$			0.2	0.4	nC

**Notes :**

1. Surface mounted on FR4 board using the minimum recommended pad size.
2. Pulse Test : Pulse width=300 $\mu s$ , duty cycle $\leq 2\%$ .
3. Switching characteristics are independent of operating junction temperature.
4. Graranted by design, not subject to producing.

Output Characteristics

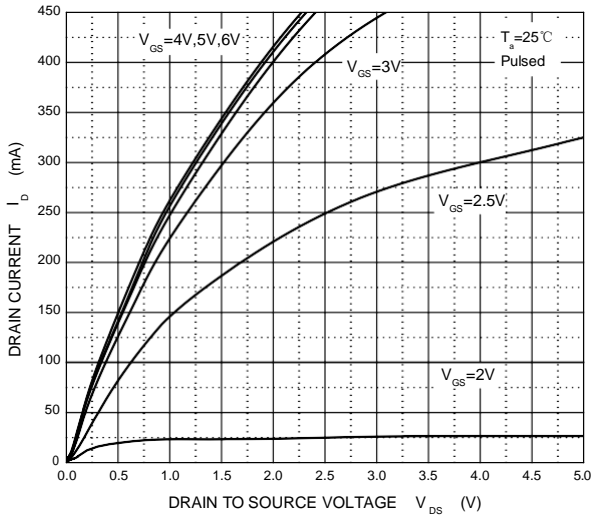

Transfer Characteristics

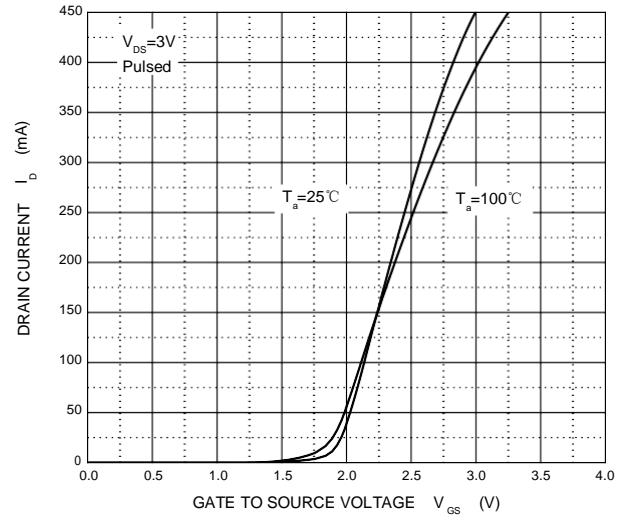

$R_{DS(ON)}$  —  $I_D$

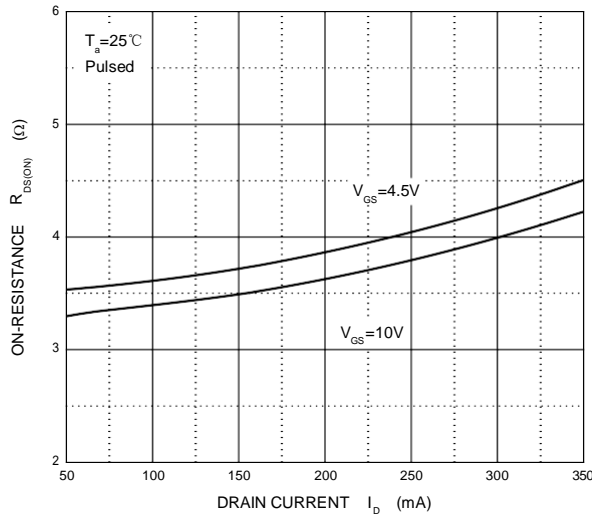

$R_{DS(ON)}$  —  $V_{GS}$

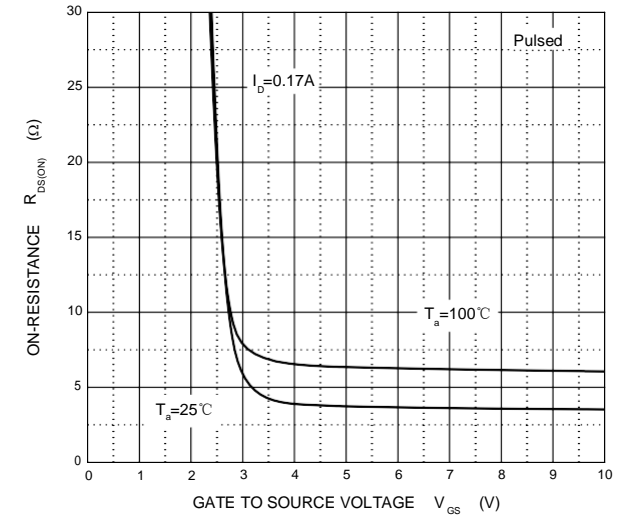

$I_S$  —  $V_{SD}$

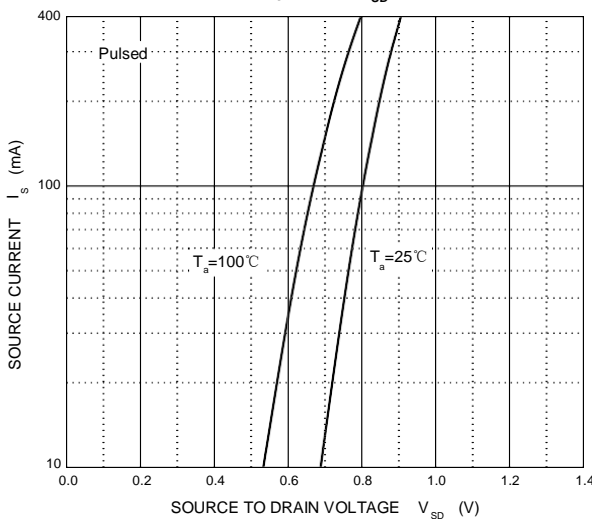

Threshold Voltage

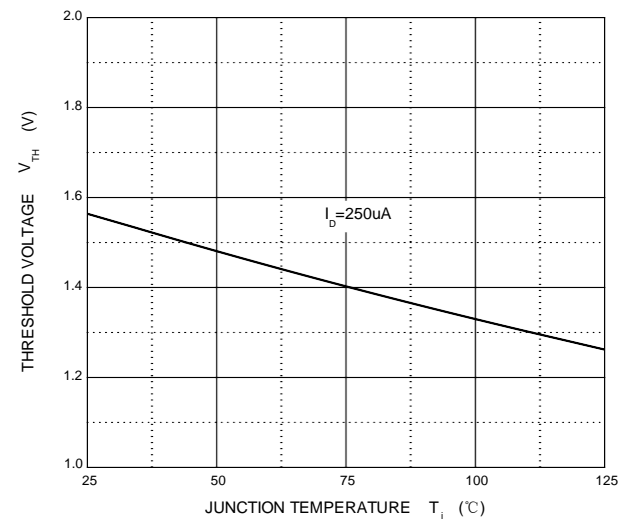

## SOT-23 Package Outline Dimensions

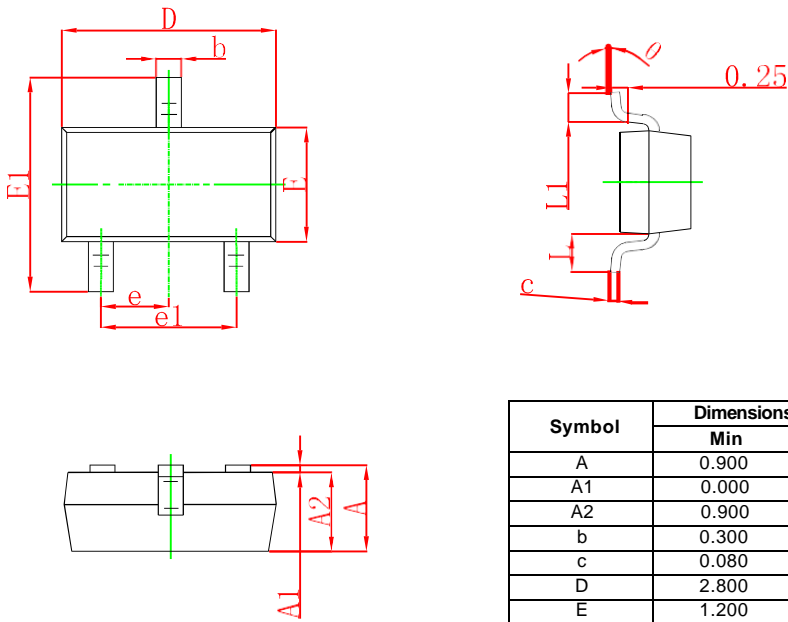

Symbol	Dimensions In Millimeters		Dimensions In Inches	
	Min	Max	Min	Max
A	0.900	1.150	0.035	0.045
A1	0.000	0.100	0.000	0.004
A2	0.900	1.050	0.035	0.041
b	0.300	0.500	0.012	0.020
c	0.080	0.150	0.003	0.006
D	2.800	3.000	0.110	0.118
E	1.200	1.400	0.047	0.055
E1	2.250	2.550	0.089	0.100
e	0.950 TYP		0.037 TYP	
e1	1.800	2.000	0.071	0.079
L	0.550 REF		0.022 REF	
L1	0.300	0.500	0.012	0.020
θ	0°	8°	0°	8°

## SOT-23 Suggested Pad Layout

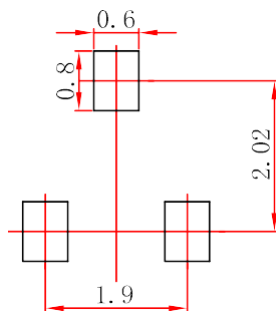

- Note:
1. Controlling dimension: in millimeters.
  2. General tolerance:  $\pm 0.05\text{mm}$ .
  3. The pad layout is for reference purposes only.

### NOTICE

JCET reserve the right to make modifications, enhancements, improvements, corrections or other changes without further notice to any product herein. JCET does not assume any liability arising out of the application or use of any product described herein.

# SOT-23 Tape and reel

## SOT-23 Embossed Carrier Tape

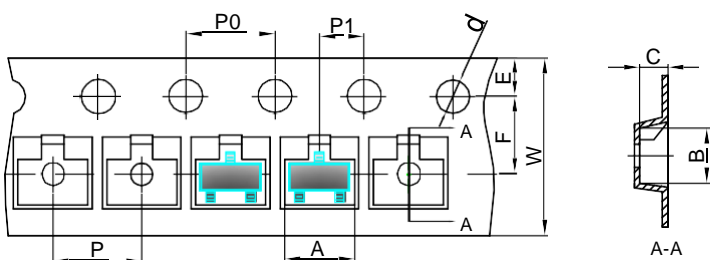

**Packaging Description:**  
 SOT-23 parts are shipped in tape. The carrier tape is made from a dissipative (carbon filled) polycarbonate resin. The cover tape is a multilayer film (Heat Activated Adhesive in nature) primarily composed of polyester film, adhesive layer, sealant, and anti-static sprayed agent. These reeled parts in standard option are shipped with 3,000 units per 7" or 17.8cm diameter reel. The reels are clear in color and is made of polystyrene plastic (anti-static coated).

Dimensions are in millimeter											
Pkg type	A	B	C	d	E	F	P0	P	P1	W	
SOT-23	3.15	2.77	1.22	Ø1.50	1.75	3.50	4.00	4.00	2.00	8.00	

## SOT-23 Tape Leader and Trailer

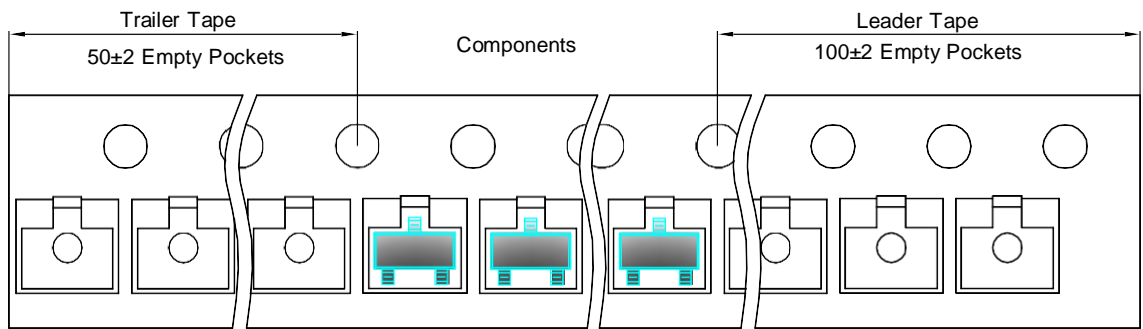

## SOT-23 Reel

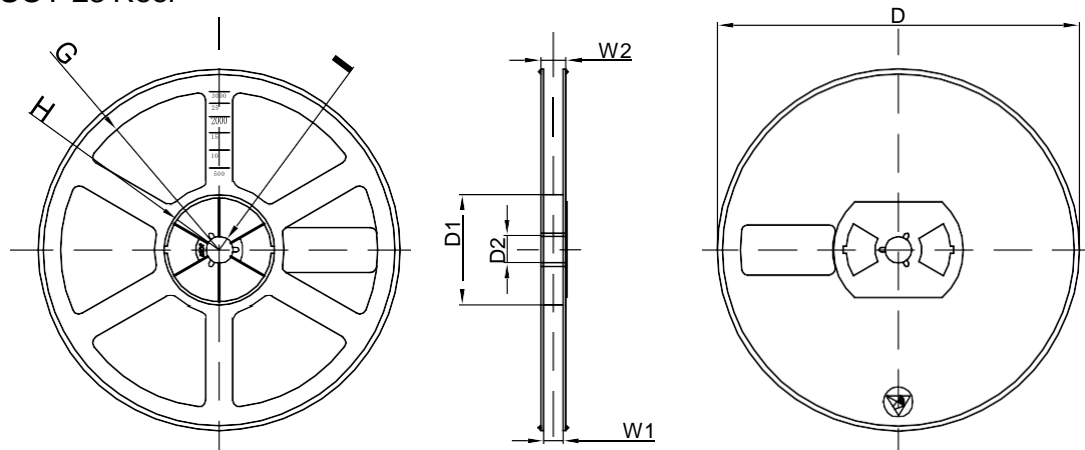

Dimensions are in millimeter								
Reel Option	D	D1	D2	G	H	I	W1	W2
7" Dia	Ø178.00	54.40	13.00	R78.00	R25.60	R6.50	9.50	12.30

REEL	Reel Size	Box	Box Size(mm)	Carton	Carton Size(mm)	G.W.(kg)
3000 pcs	7 inch	30,000 pcs	203x203x195	120,000 pcs	438x438x220	