

**NEC**  
ELECTRON DEVICE

MOS FIELD EFFECT TRANSISTOR

# 2SK817

## FAST SWITCHING N-CHANNEL SILICON POWER MOS FET

### PACKAGE DIMENSIONS (Unit: mm)

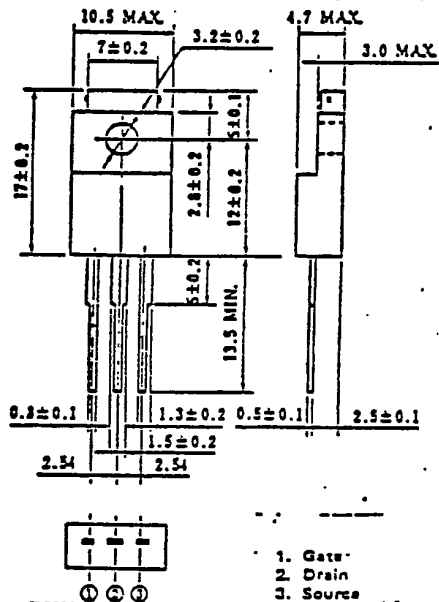

### Features

- Suitable for switching power supplies, actuator controls and pulse circuits
- 4V Gate Drive — Logic level —
- Low RDS(on)
- Large Current Switching : ID(DC)=26A
- No Second breakdown

### Absolute Maximum Ratings(Ta=25°C)

Drain to Source Voltage	VDS	60V
Gate to Source Voltage	VGS	± 20V
Continuous Drain Current	ID(DC)	± 26A
Pulse Drain Current	ID(pulse)	* ± 10±A
Total Power Dissipation	PT	2.0W
Total Power Dissipation	PT**	35W
Channel Temperature	Tch	150 °C
Storage Temperature	Tstg	-55to+150 °C
	* Tch	≤ 150 °C
	** Tc	25 °C

### Electrical Characteristics (Ta=25 °C)

Characteristics	Symbol	Min.	Typ.	Max.	Unit	Test Conditions
Drain Leakage Current	IDSS			10	μA	VDS= 60V, VGS=0
Gate to Source Leakage Current	IGSS			±100	nA	VGS=±20V, VDS=0
Gate to Source Cutoff Voltage	VGS(off)	1.0		2.5	V	VDS=10V, ID=1.0mA
Forward Transfer Admittance	yfs	8.0	17		S	VDS=10V, ID=15A
Drain To Source On-State Resistance	RDS(on)		0.04	0.055	Ω	VGS=10V, ID=15A
Drain to Source On-State Resistance	RDS(on)		0.06	0.08	Ω	VGS=4.0V, ID=15A
Input Capacitance	Ciss		2100		pF	VDS= 10V
Output Capacitance	Coss		800		pF	VGS=0
Reverse Transfer Capacitance	Crss		200		pF	f=1.0MHz
Turn-On Delay Time	td(on)		20		ns	ID= 15A
Rise Time	tr		20		ns	VGS(on)= 10V
Turn-Off Delay Time	td(off)		120		ns	Vcc= 30V
Fall Time	tf		140		ns	RL=2 Ω

6427525 N E C ELECTRONICS INC

98D 18983

D

T-39-11

TURN-ON AND TURN-OFF TIME TEST CIRCUIT

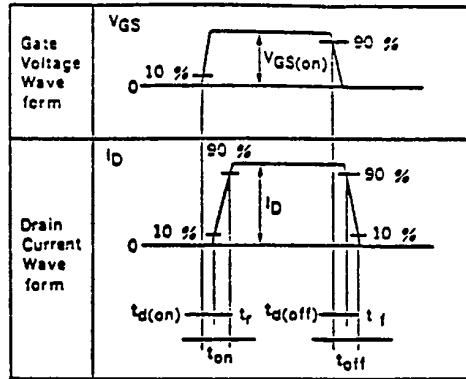
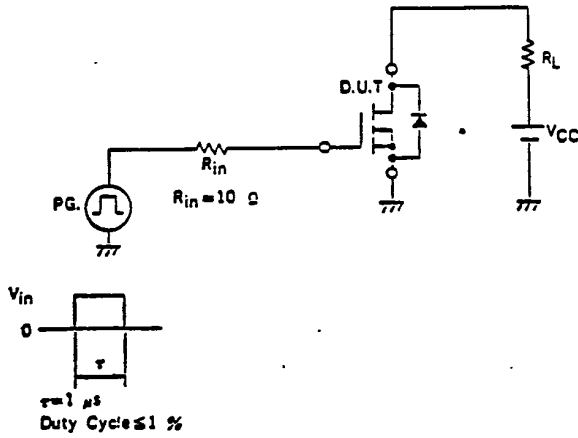

DERATING FACTOR OF FORWARD BIAS SAFE OPERATING AREA

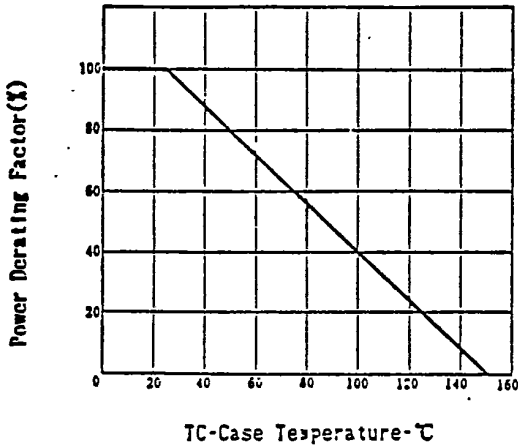

FORWARD BIAS SAFE OPERATING AREA

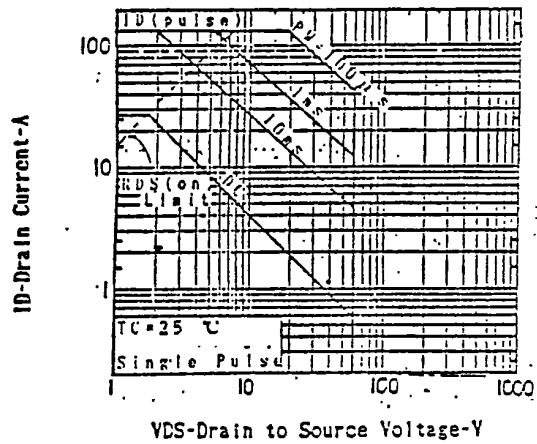

TOTAL POWER DISSIPATION vs. CASE TEMPERATURE

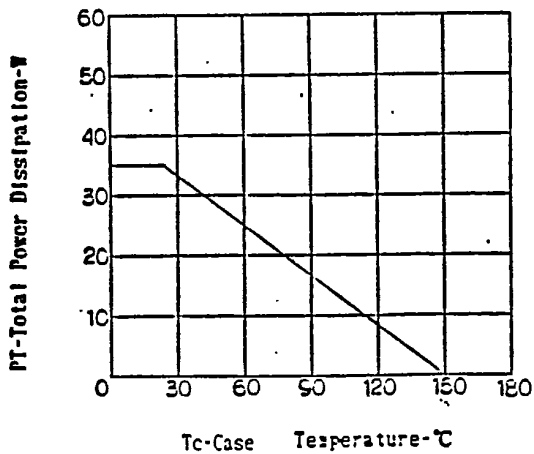

DRAIN CURRENT vs. DRAIN TO SOURCE VOLTAGE

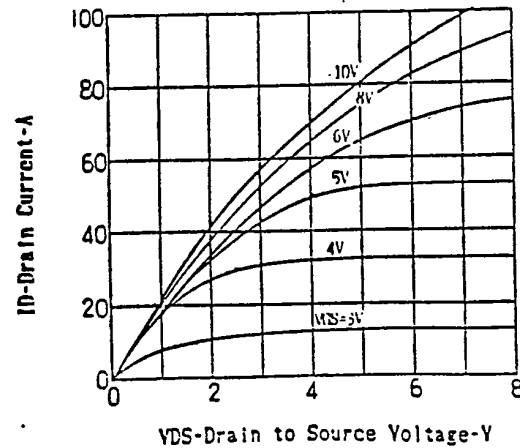

FORWARD TRANSFER ADMITTANCE vs. DRAIN CURRENT

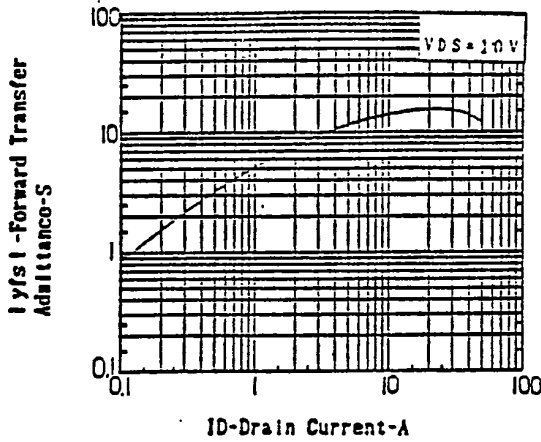

SOURCE TO DRAIN DIODE FORWARD VOLTAGE

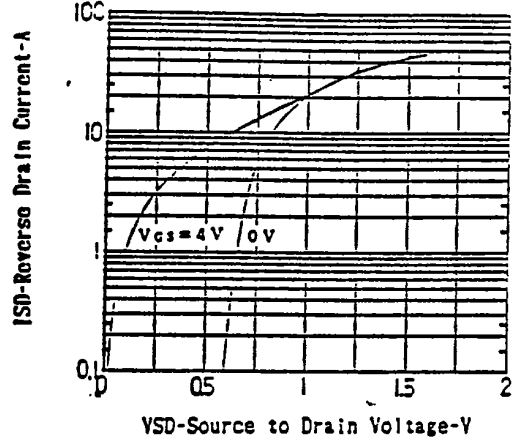

CAPACITANCE vs. DRAIN TO SOURCE VOLTAGE

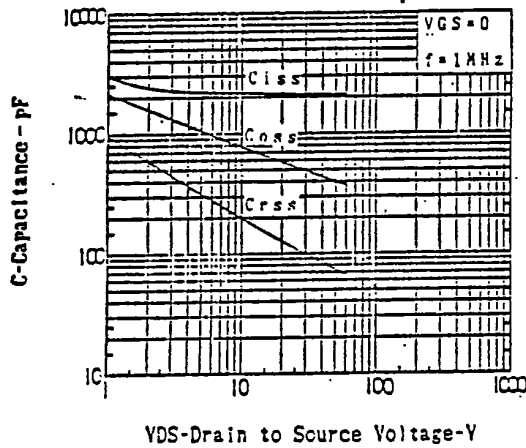

DRAIN TO SOURCE ON-STATE RESISTANCE vs. GATE TO SOURCE VOLTAGE

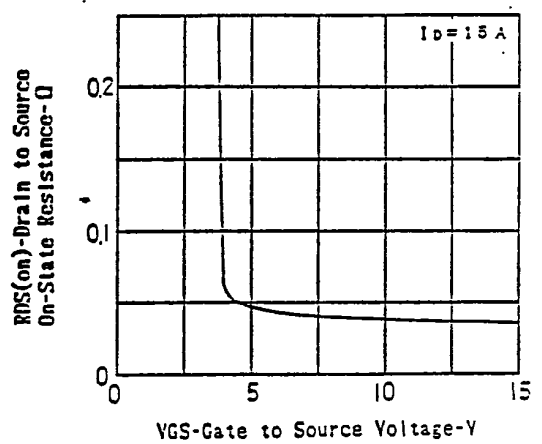

DRAIN TO SOURCE ON-STATE RESISTANCE vs. CHANNEL TEMPERATURE

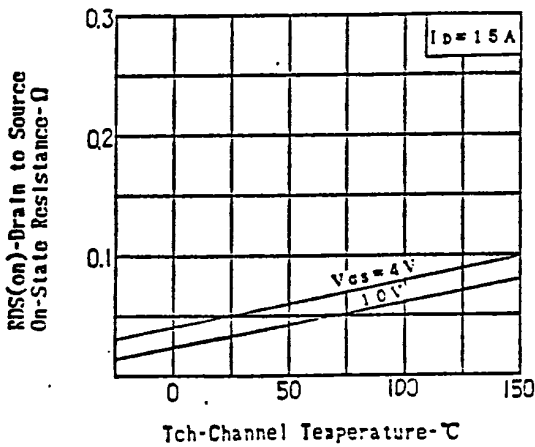

DRAIN TO SOURCE ON-STATE RESISTANCE vs. DRAIN CURRENT

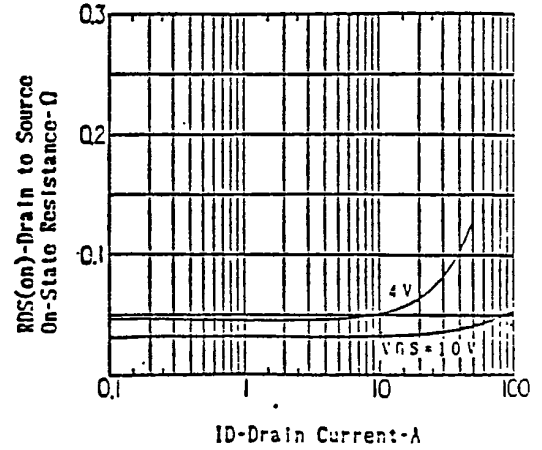

6427525 N E C ELECTRONICS INC

98D 18985 D T-39-11

