



NDB2 Series Miniature Circuit Breakers

Edition 2016

Nader

CONTENTS

NDB2 series miniature circuit breakers	1-1
■ Product overview	1-2
■ Product features	1-2
■ Application scope	1-4
■ Technical characteristics of the product	1-5
Description of specifications and models	1-5
Description of specifications and models of NDB2-63K	1-6
Technical parameters	1-7
Tripping characteristic curve	1-8
■ Accessories	1-10
List of accessories	1-10
NDB2-63/NDB2T-63 accessories forms	1-10
■ Outline and installation dimension	1-11
NDB2-40 outline dimension	1-11
NDB2-63/NDB2T-63 outline dimension	1-11
NDB2T-63UL489 outline dimension	1-12
NDB2-63K outline dimension	1-12
■ Electric circuit diagram	1-13
■ Specifications for ordering or selection	1-14

CONTENTS

NDB2Z series miniature circuit breakers	2-1
■ Product overview	2-2
■ Product features	2-2
■ Application scope	2-4
■ Technical characteristics of the product	2-5
Description of specifications and models of NDB2Z-63	2-5
Description of specifications and models of NDB2ZB-40	2-6
Technical parameters	2-6
Tripping characteristic curve	2-7
■ Accessories	2-8
NDB2Z-63/NDB2Z-63(PV) accessories forms	2-8
■ Outline and installation dimension	2-9
NDB2Z-63 outline dimension	2-9
NDB2Z-63(PV) outline dimension	2-9
NDB2ZB-40 outline dimension	2-10
■ Electric circuit diagram	2-11
■ Specifications for ordering or selection	2-12

CONTENTS

OF2, SD2, NFS2, MX+OF2, NGQ2A, ATM, TM2 accessories	3-1
■ Product overview	3-2
■ Scope of application	3-3
■ Technical characteristics of the product	3-4
OF2 auxiliary contact	3-4
SD2 alarm contact	3-5
NFS2 auxiliary and alarm contact group	3-6
MX + OF2 shunt tripper	3-7
NGQ2A overvoltage and under-voltage tripper	3-8
ATm reclosing control accessories	3-9
Tm2	3-10
■ Outline and installation dimension	3-11
OF2, SD2 outline dimension	3-11
NFS2 outline dimension	3-11
MX+OF2, NGQ2A outline dimension	3-12
ATm outline dimension	3-12
Tm2 outline dimension	3-13
■ Product wiring diagram	3-14
■ Specifications for ordering or selection	3-16

CONTENTS

Tm2 series electric operating mechanisms _____ 4-1

■ Product overview _____	4-2
■ Scope of application _____	4-2
■ Application scope _____	4-3
■ Technical characteristics of the product _____	4-4
■ Outline and installation dimension _____	4-5
■ Product wiring diagram _____	4-5
■ Package and storage _____	4-6
■ Matters needing attention _____	4-6

Tm2GQ overvoltage and under-voltage auto-reclosure accessory _____ 5-1

■ Product overview _____	5-2
■ Scope of application _____	5-2
■ Application scope _____	5-3
■ Technical characteristics of the product _____	5-4
■ Outline and installation dimension _____	5-5
■ Product wiring diagram _____	5-5
■ Package and storage _____	5-6
■ Matters needing attention _____	5-6

CONTENTS

JS1-11Y/B2-63 mechanical interlock _____	6-1
■ Product overview _____	6-2
■ Scope of application _____	6-2
■ Application scope _____	6-3
■ Technical characteristics of the product _____	6-3
■ Outline and installation dimension _____	6-4
■ Package and storage _____	6-4
■ Matters needing attention _____	6-4

CONTENTS

目录

NDB2LE series residual current

operated circuit breakers _____ 7-1

■ Product overview _____ 7-2

■ Product features _____ 7-2

■ Application scope _____ 7-4

■ Technical characteristics of the product _____ 7-5

Description of specifications and models _____ 7-5

Technical parameters _____ 7-6

Product tripping curve _____ 7-8

■ Accessories _____ 7-11

List of accessories _____ 7-11

NDB2LE-63 accessories forms _____ 7-12

■ Outline and installation dimension _____ 7-12

NDB2LE-25 outline dimension _____ 7-12

NDB2LE-63 outline dimension _____ 7-13

■ Electric circuit diagram _____ 7-15

■ Specifications for ordering or selection _____ 7-16





NDB2 Series Miniature Circuit Breakers

Edition 2016

Nader

1. Product Overview

					
Product models	NDB2-40	NDB2-63	NDB2T-63	NDB2T-63 (UL489)	NDB2-63K
Rated operational voltage (V)	AC230/240	AC230/240 (1P) AC400/415(2P/3P/4P) DC80(1P/2P)	AC230/240 (1P) AC400/415(2P/3P/4P) DC60/80 (1P) DC80/125 (2P)	AC120/240 AC277/480 DC60(1P/2P) DC125(2P)	AC230/240
Rated operating current (A)	2 ~ 40A	1 ~ 63A	1 ~ 63A	1 ~ 63A	1 ~ 63A
Number of poles	1P+N	1P、2P、3P、4P	1P、2P、3P、4P	1P、2P、3P	1P+N
Product certification	CCC、CE、TUV、UL1077	CCC、CE、TUV、UL1077	CCC、CE、TUV、UL1077	UL489	CCC

2. Product Features

● Scope of application and purpose

NDB2 series circuit breakers provide short circuit protection, overload protection, control, isolation, etc. They are applicable to low-voltage terminal power distribution in such fields as industry, civil construction, energy, communications and infrastructure.

● Design features

- ◆ Quick closure: ensures reliable operation of impact load and prolongs the service life of circuit breaker
- ◆ The product structure provides short-circuit current limitation and improves short-circuit breaking capacity
- ◆ Frame wiring structure: Reliable wiring
- ◆ Supporting a variety of accessories: Simple and convenient function extension
- ◆ Modulization and modularization: Arbitrary combination

● Structural features

- ◆ Structures and features of NDB2 product

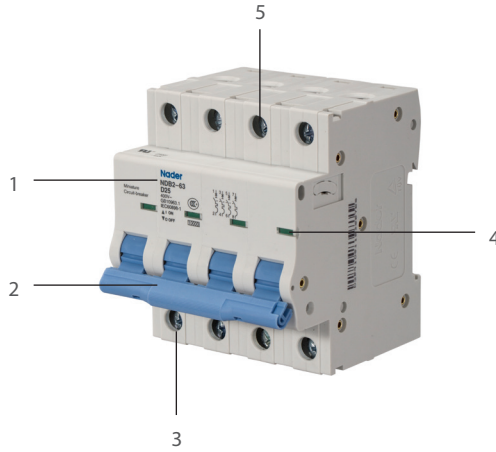

- 1: Product model
- 2: Handle
- 3: Incoming and outgoing line ends
- 4: Opening/closing indication

- ◆ NDB2(UL489) Structures and features of the product

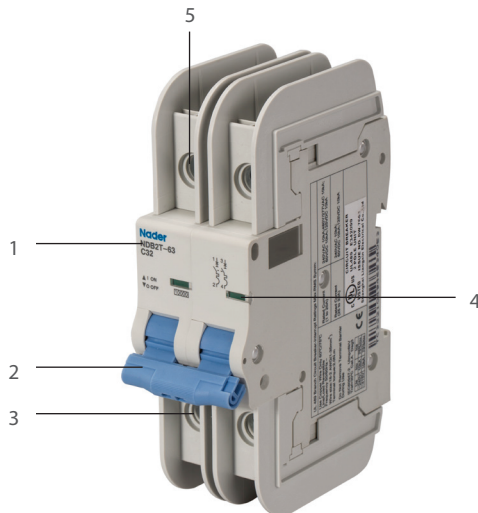

- 1: Product model
- 2: Handle
- 3: Incoming and outgoing line ends
- 4: Opening/closing indication

● Meeting the following standards

- ◆ GB10963.1 Circuit breakers with overcurrent protection for household and similar places - Part 1: Circuit breakers for AC.
- ◆ GB14048.2 Low-voltage switchgear and controlgear Part 2: Circuit breaker.
- ◆ IEC 60898-1 Electrical accessories-Circuit-breakers for overcurrent protection for house hold and similar installation-Part 1.
- ◆ IEC 60947-2 Low-voltage switchgear and controlgear-Part 2.

3. Application Scope

● Electrical symbols



● Applicable environment

- ◆ Temperature of the working environment/storage temperature
Temperature of the working environment: $-35^{\circ}\text{C}\sim+70^{\circ}\text{C}$, the average value in 24h is not more than $+35^{\circ}\text{C}$
Storage temperature: $-35^{\circ}\text{C}\sim+70^{\circ}\text{C}$
- ◆ Altitude
Installation site altitude $\leq 2,000\text{m}$.
- ◆ Relative humidity for operation/Relative humidity for storage
The relative humidity of atmosphere is not more than 50% at the ambient air temperature of $+40^{\circ}\text{C}$; at a lower temperature, a higher relative humidity is allowed, for example, 90% at 20°C . Special measures should be taken to deal with occasional condensation due to temperature change.

● Pollution grade

2 poles

● Protection grade

Product protection grade: IP20

● Installation category

Class II (load level), Class III (power distribution and control level), Class IV (power level)

● Installation mode

Installed on the TH35mm \times 7.5 (EN50022) standard rails

● Installation direction

Installed in any direction

● Environmental protection requirements

Products meet the RoHS standard

4. Technical Characteristics of the Product

4.1 Description of Specifications and Models

Serial No.	Serial No. name	Code explanation			
1	Enterprise code	ND: Nader brand low-voltage apparatus			
2	Model	B: Miniature Circuit Breakers			
3	Design serial No.	2			
4	Meeting the following standards	None: GB 10963.1	T: GB 14048.2		
5	Frame grade	40	63	63	63
6	Tripping characteristic	B、C	B、C、D	B、C、D	B、C、D
7	Rated current	2、4、6、10、16、20、25、32、40	1、2、3、4、5、6、8、10、12、13、16、20、25、32、40、50、63	1、1.2、1.5、1.6、2、3、4、5、6、7、8、10、12、13、15、16、20、25、30、32、35、40、50、60、63	1、1.2、1.5、1.6、2、4、5、6、7、8、10、12、13、15、16、20、25、30、32、35、40、50、60、63
8	Number of poles	None: 1PN	1: 1P, 2: 2P 3: 3P, 4: 4P	1: 1P, 2: 2P 3: 3P, 4: 4P	1: 1P, 2: 2P 3: 3P
9	None: CC、CE、TUV、UL1077	None: CCC、CE、TUV、UL1077	None: CCC、CE、TUV、UL1077	None: CCC、CE、TUV、UL1077	None: UL489

4.2 Description of Specifications and Models of NDB2-63K

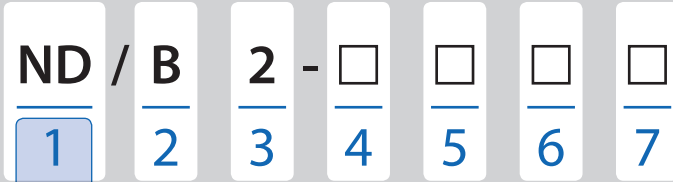

Serial No.	Serial No. name	Code explanation
1	Enterprise code	ND: Nader brand low-voltage apparatus
2	Model	B: Miniature Circuit Breakers
3	Design serial No.	2
4	Frame grade	63
5	Phase line + neutral line	K
6	Tripping characteristic	C
7	Rated current	1、2、4、6、10、16、20、25、32、40、50、63

4.3 Technical Parameters

Model	NDB2-40	NDB2-63	NDB2T-63	NDB2T-63 (UL489)	NDB2-63K
Rated voltage	AC230/240	AC230/240 (1P) AC400/415 (2P/3P/4P) DC80 (1P/2P)	AC230/240 (1P) AC400/415 (2P/3P/4P) DC60/80 (1P) DC60/80 (2P)	AC120/277 (1P) AC240 (2P/3P) AC480Y/277 (2P/3P) DC60 (1P/2P) DC125 (2P)	AC230
Rated insulation voltage	400V	1000V	1000V	1000V	230V
Rated impulse withstand voltage	4kV	6kV	6kV	6kV	6kV
Rated current	2A、4A、6A、 10A、16A、 20A、25A、 32A、40A	1A、2A、3A、 4A、5A、6A、 8A、10A、12A、 13A、16A、20A、 25A、32A、40A、 50A、63A	1A、1.2A、1.5A、 1.6、2A、3A、 4A、5A、6A、 7A、8A、10A、 10A、12A、13A、 15A、16A、20A、 25A、30A、32A、 35A、40A、50A、 63A	1A、1.2A、1.5A、 1.6A、2A、3A、 4A、5A、6A、7A、 8A、10A、12A、 13A、15A、16A、 20A、25A、30A、 32A、40A、50A、 60A、63A	1A、2A、4A、 6A、10A、16A、 20A、25A、32A、 40A 50A、63A
Rated short-circuit breaking capacity	6kA	10kA	/	AC120/240 10kA AC277V/480 10kA(1-32A)	6kA
Rated ultimate short-circuit breaking capacity	/	/	10kA	/	/
Rated running short-circuit breaking capacity	6kA	7.5kA	7.5kA	/	6kA
Instantaneous tripping characteristic	B: 3 ~ 5I _n C: 5 ~ 10I _n	B: 3 ~ 5I _n C: 5 ~ 10I _n D: 10 ~ 14I _n	B: 4I _n ± 20% C: 8I _n ± 20% D: 12I _n ± 20%	B: 4I _n ± 20% C: 8I _n ± 20% D: 12I _n ± 20%	C: 5 ~ 10I _n
Mechanical/ Electrical life	10000/10000	20000/10000	20000/10000	10000/10000	20000/10000
Number of poles	1PN	1P/2P/3P/4P	1P/2P/3P/4P	1P/2P/3P	1PN
Meeting the following standards	GB 10963.1 IEC 60898-1 UL1077	GB 10963.1 IEC 60898-1 UL1077	GB 14048.2 IEC 60947-2 UL1077	UL489	GB 10963.1 IEC 60898-1

4.4 Tripping Characteristic Curve

● NDB2-40

Type B (3 ~ 5 In)

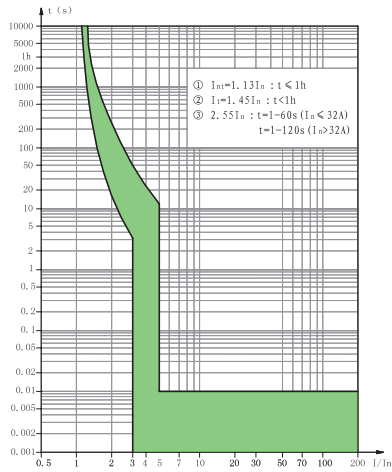

Type C (5 ~ 10 In)

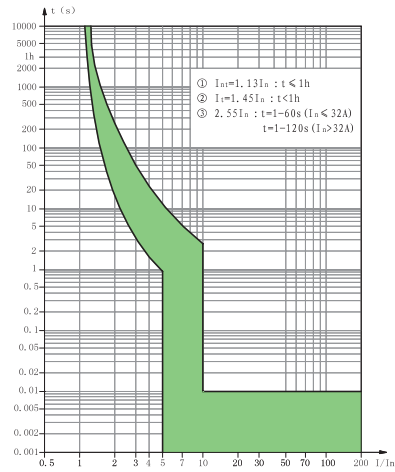

● NDB2-63

Type B (3 ~ 5 In)

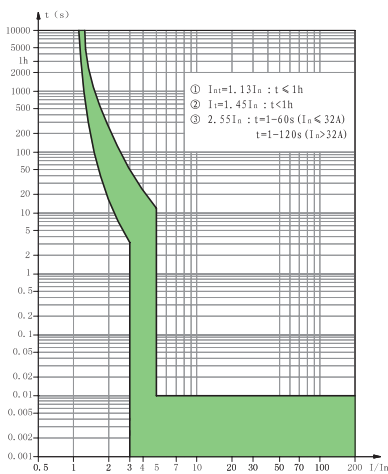

Type C (5 ~ 10 In)

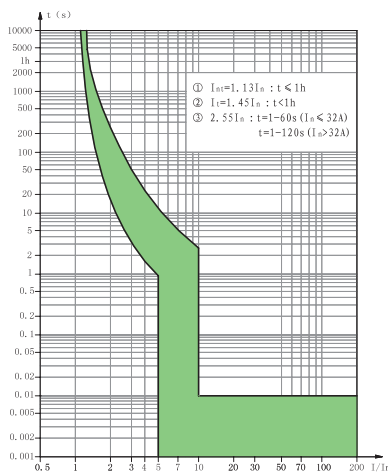

Type D (10 ~ 14 In)

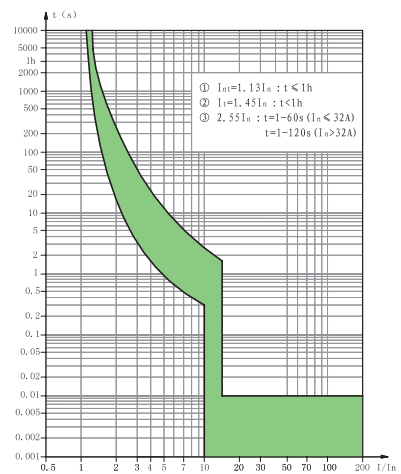

● NDB2T-63/ NDB2T-63 UL489

Type B 4 In (1 ± 20%)

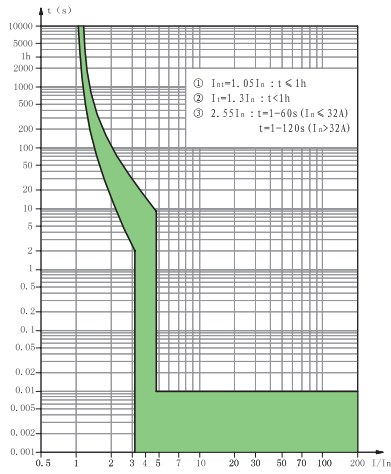

Type C 8 In (1 ± 20%)

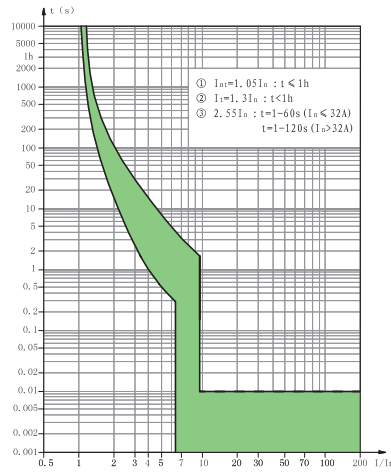

Type D 12 In (1 ± 20%)

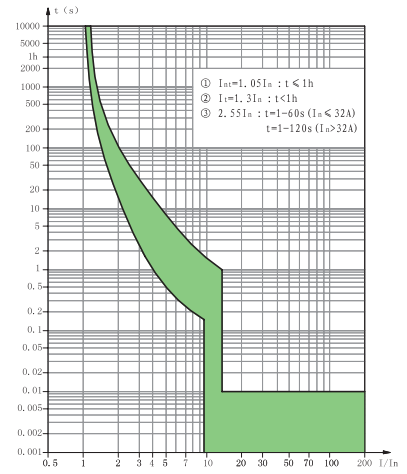

● NDB2-63K

Type C (5 ~ 10 In)

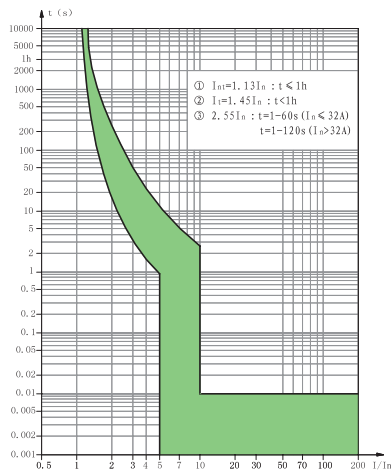

5. Accessories

● List of accessories

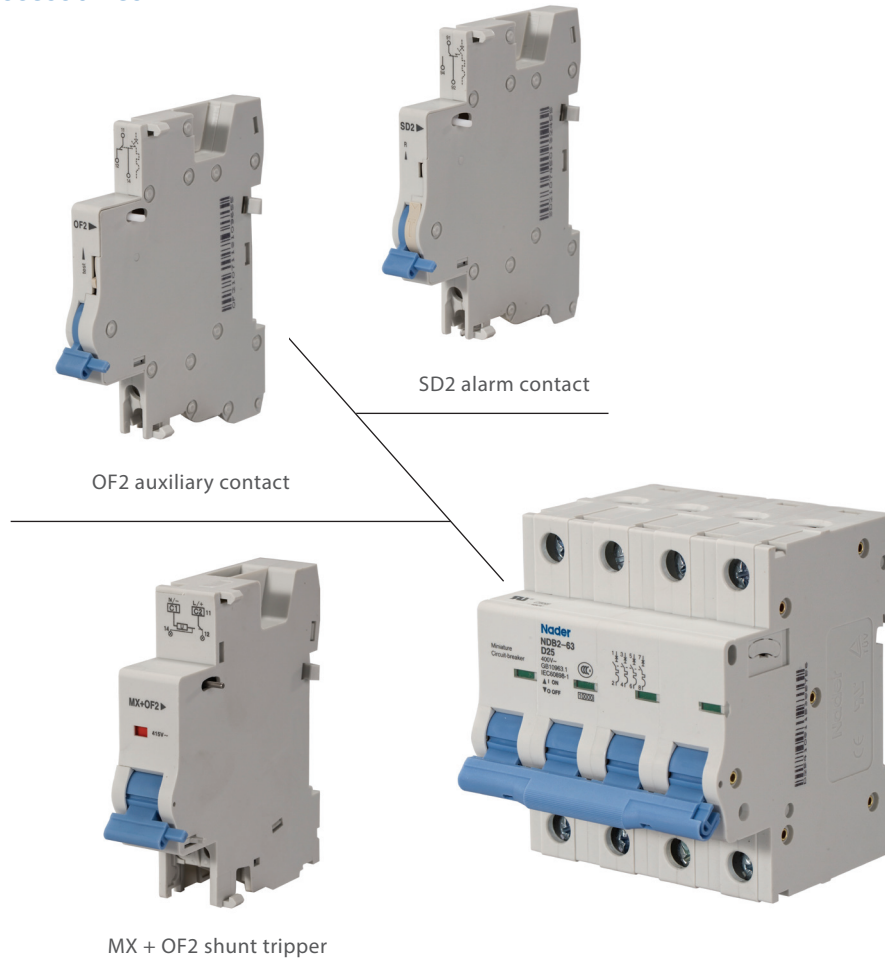

● NDB2-63/NDB2T-63 accessories forms

Serial No.	Name	Accessory code	Function and number of loading
1	Auxiliary contact	OF2	Loaded on the left side of a miniature circuit breaker to indicate the On/Off state of the circuit breaker; 3 can be loaded at most
2	Alarm contact	SD2	Loaded on the left side of a miniature circuit breaker to indicate the fault trip state of the circuit breaker; 3 can be loaded at most
3	Shunt tripper	MX+OF2	Loaded on the left side of a miniature circuit breaker to indicate the fault tripping state and remote breaking control of the circuit breaker;

Note: For details of accessory parameters, see “OF2, SD2 and MX+OF2” samples

6. Outline and Installation Dimension

6.1 NDB2-40 Outline Dimension

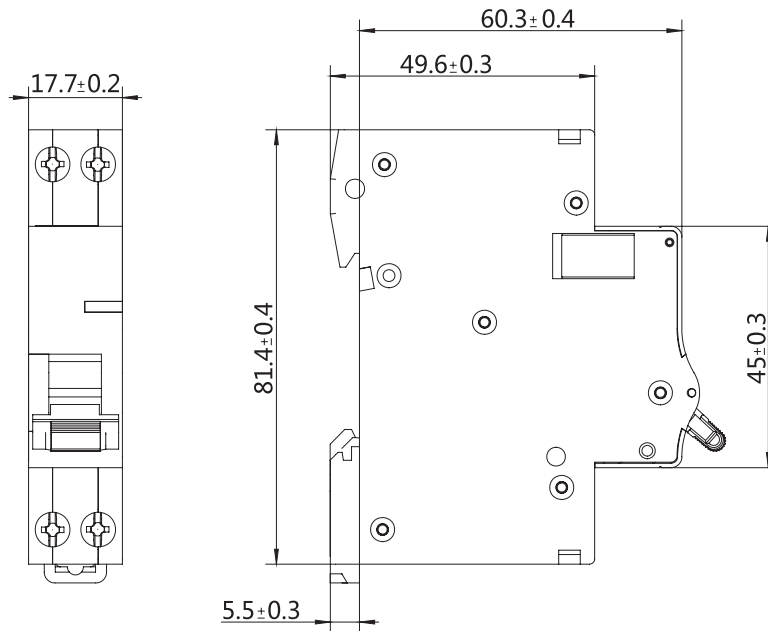

6.2 NDB2-63/NDB2T-63 Outline Dimension

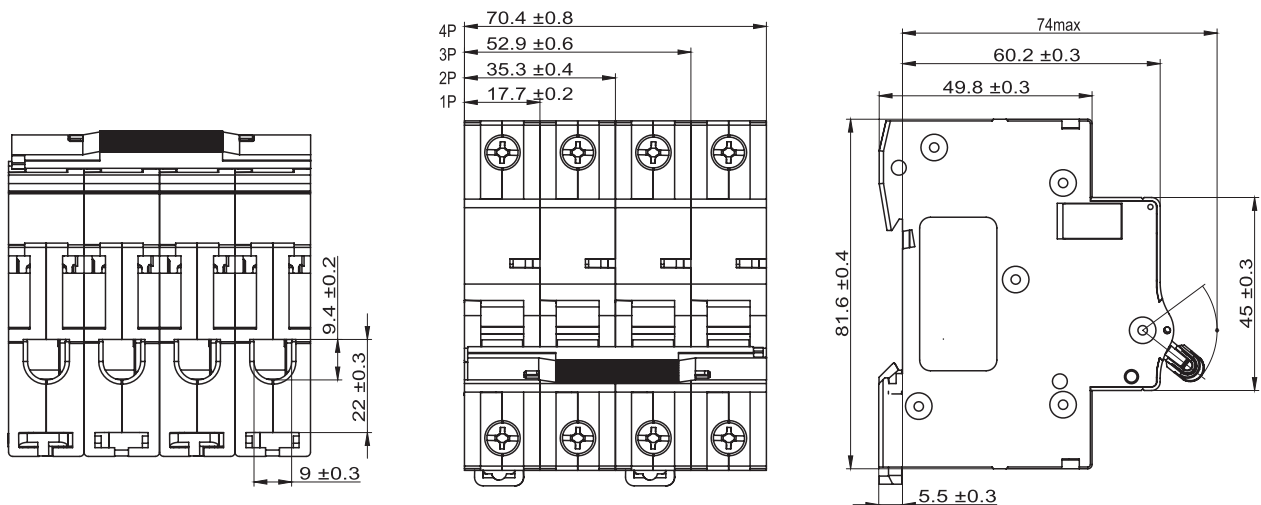

6.3 NDB2T-63UL489 Outline Dimension

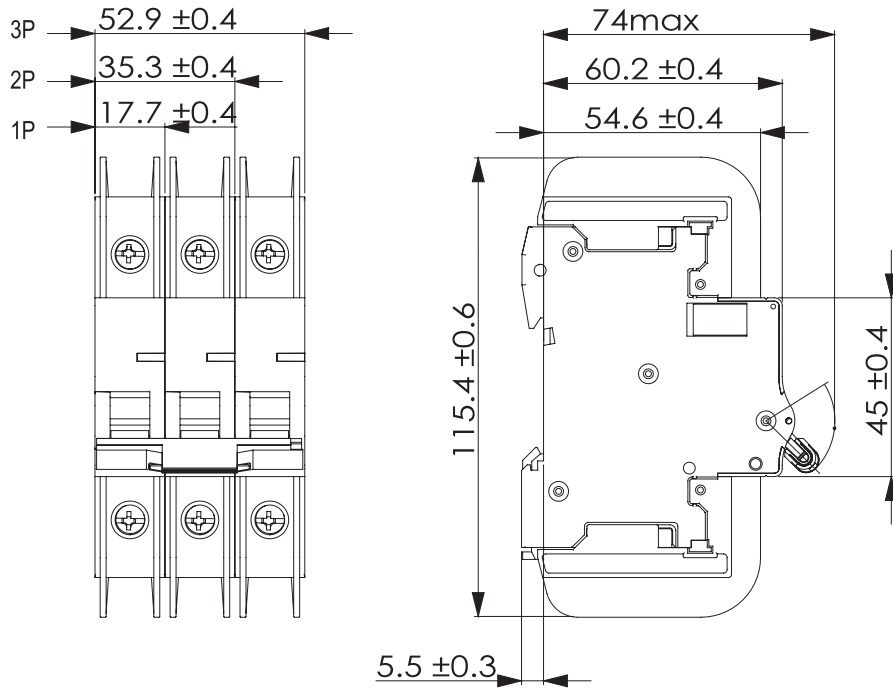

6.4 NDB2-63K Outline Dimension

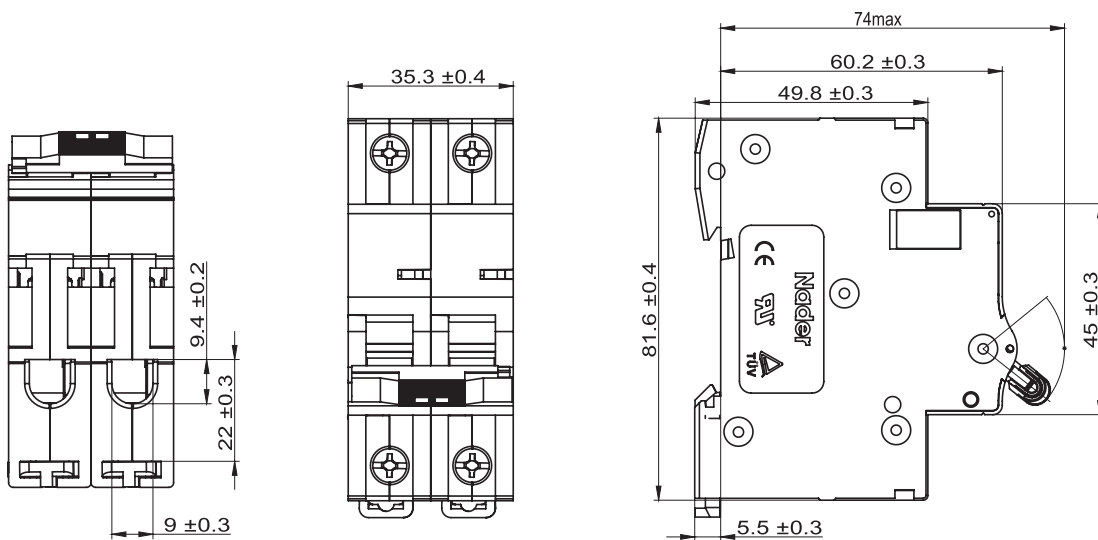

7. Electric Circuit Diagram

● NDB2-40 / NDB2-63K

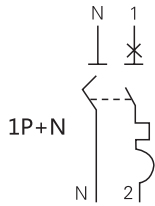

● NDB2-63/NDB2T-63/NB2T-63 UL489

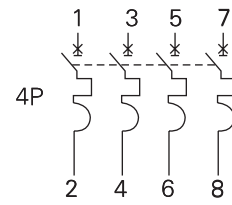
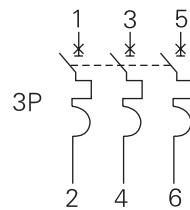
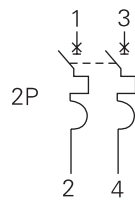

8. Specifications for Ordering and Selection (Tick ✓ in)

User unit				Number of units ordered:	Date of order:
Model	<input type="checkbox"/> NDB2-40	<input type="checkbox"/> NDB2-63	<input type="checkbox"/> NDB2T-63	<input type="checkbox"/> NDB2T-63 UL489	<input type="checkbox"/> NDB2-63k
Rated operating current	2, 4, 6, 10, 16, 20, 25, 32, 40	1, 2, 3, 4, 5, 6, 8, 10, 12, 13, 16, 20, 25, 32, 40, 50, 63	1, 1.2, 1.5, 1.6, 2, 3, 4, 5, 6, 7, 8, 10, 12, 13, 15, 16, 20, 25, 30, 32, 40, 50, 60, 63	1, 1.2, 1.5, 1.6, 2, 3, 4, 5, 6, 7, 8, 10, 12, 13, 15, 16, 20, 25, 30, 32, 40, 50, 60, 63	1, 2, 4, 6, 10, 16, 20, 25, 32, 40, 50, 63
Tripping type	<input type="checkbox"/> B, <input type="checkbox"/> C	<input type="checkbox"/> B, <input type="checkbox"/> C, <input type="checkbox"/> D	<input type="checkbox"/> B, <input type="checkbox"/> C, <input type="checkbox"/> D	<input type="checkbox"/> B, <input type="checkbox"/> C, <input type="checkbox"/> D	<input type="checkbox"/> C
Number of poles	<input type="checkbox"/> 1PN	<input type="checkbox"/> 1P, <input type="checkbox"/> 2P <input type="checkbox"/> 3P, <input type="checkbox"/> 4P	<input type="checkbox"/> 1P, <input type="checkbox"/> 2P <input type="checkbox"/> 3P, <input type="checkbox"/> 4P	<input type="checkbox"/> 1P, <input type="checkbox"/> 2P, <input type="checkbox"/> 3P	<input type="checkbox"/> 1PN





NDB2Z Series Miniature Circuit Breakers

Edition 2016

Nader

1. Product Overview

			
Product models	NDB2Z-63	NDB2Z-63 (PV)	NDB2ZB-40
Rated operational voltage (V)	DC250V(1P)/DC500V(2P)	DC750V(3P)/DC1000V(4P)	DC250V
Rated operating current (A)	1 ~ 63A	1 ~ 63A	10 ~ 40A
Number of poles	1P、2P	3P、4P	1PN
Product certification	CCC		

2. Product Features

● Scope of application and purpose

NDB2Z series circuit breakers are applicable to low-voltage terminal power distribution in such fields as industry, civil construction, energy, communication and infrastructure.

● Design features

- ◆ Quick closure: ensures reliable operation of impact load and prolongs the service life of circuit breaker
- ◆ Frame wiring structure: Reliable wiring
- ◆ Supporting a variety of accessories: Simple and convenient function extension
- ◆ Modulization and modularization: Arbitrary combination

● Structural features

- ◆ NDB2-63 External structural drawing

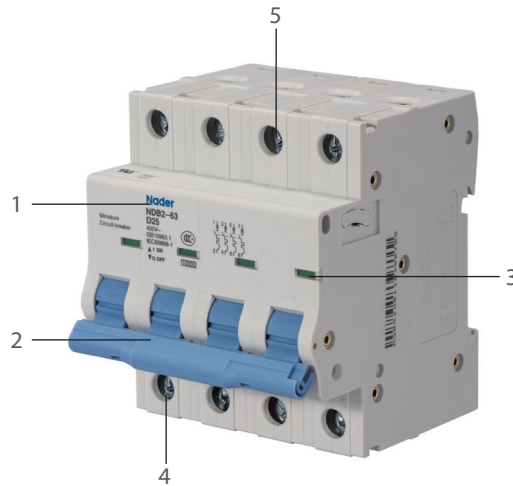

1. Product model
2. Handle
3. Closing indication
4. Outgoing line terminal
5. Incoming line terminal

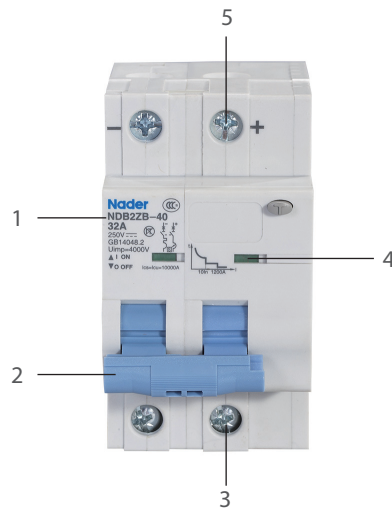

1. Product model
2. Handle
3. Outgoing line terminal
4. Closing indication
5. Incoming line terminal

● Meeting the following standards

- ◆ GB14048.2 Low-voltage switchgear and controlgear - Part 2: Circuit breaker.
- ◆ IEC 60947-2 Low-voltage switchgear and controlgear-Part 2.

3. Application scope

● Electrical symbols



● Applicable environment

- ◆ Temperature of the working environment/storage temperature

Use temperature: $-35^{\circ}\text{C}\sim+70^{\circ}\text{C}$, the average value in 24h is not more than $+35^{\circ}\text{C}$

Storage temperature: $-35^{\circ}\text{C}\sim+70^{\circ}\text{C}$

- ◆ Altitude

Installation site altitude $\leq 2,000\text{m}$.

- ◆ Relative humidity for operation/Relative humidity for storage

The relative humidity of atmosphere is not more than 50% at the ambient air temperature of $+40^{\circ}\text{C}$; at a lower temperature, a higher relative humidity is allowed, for example, 90% at 20°C . Special measures should be taken to deal with occasional condensation due to temperature change.

● Pollution grade

- ◆ 3 poles

● Protection grade

- ◆ Product protection grade: IP20

● Installation category

- ◆ II Class II (load level) and Class III (power distribution and control level)

● Installation way

- ◆ Installed on the TH35mm \times 7.5 standard guard rail

● Installation direction

- ◆ Vertical installation, with the gradient between the installation plane and the vertical plane $\leq \pm 5^{\circ}$
- ◆ Horizontal installation

● Environmental protection requirements

- ◆ Products meet the RoHS standard

4. Technical Characteristics of the Product

4.1 Description of Specifications and Models of NDB2Z-63

Serial No.	Serial No. name	Code explanation
1	Enterprise code	ND : Nader brand low-voltage apparatus
2	Model	B : Disconnecting switch
3	Design serial No.	2
4		Z : DC
5	Frame grade	63
6	Tripping characteristic	B、C
7	Rated current	1、1.2、1.5、1.6、2、3、4、5、6、7、8、10、12、13、15、16、20、25、30、32、35、40、50、60、63
8	Grade number	Conventional products: 1 : 1P、2 : 2P PV: 3 : 3P、4 : 4P
9	PV code	None: Conventional product PV: Indicates PV use

4.2 Description of Specifications and Models of NDB2ZB-40

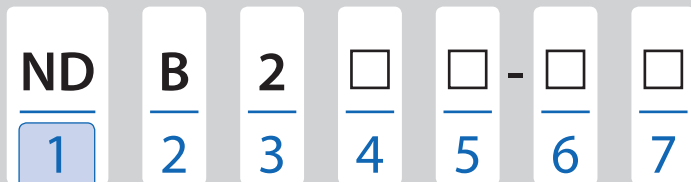

Serial No.	Serial No. name	Code explanation
1	Enterprise code	ND: Nader brand low-voltage apparatus
2	Model	B: Miniature Circuit Breakers
3	Design serial No.	2
4	DC	Z: DC
5	Function code	B: Three-section protection
6	Frame grade	40
7	Rated current	10、16、20、25、32、40

4.3 Technical Parameters

Specifications	NDB2Z-63	NDB2Z-63 (PV)	NDB2ZB-40
Rated operational voltage	DC250V(1P)/DC500V(2P)	DC750V(3P)/DC1000V(4P)	DC250V
Rated insulation voltage	1000V	1000V	1000V
Rated impulse withstand voltage	6kV	6kV	4kV
Rated current	1A、1.2A、1.5A、1.6A、2A、3A、4A、5A、6A、7A、8A、10A、12A、13A、15A、16A、20A、25A、30A、32A、40A、50A、63A、		10A、16A、20A、25A、32A、40A
Rated ultimate short-circuit breaking capacity	10kA	10kA	10kA
Rated running short-circuit breaking capacity	7.5kA	7.5kA	10kA
Instantaneous tripping characteristic	B: $6I_n \pm 20\%$ C: $12I_n \pm 20\%$	B: $6I_n \pm 20\%$ C: $12I_n \pm 20\%$	8In: No tripping within 200ms 10In: Tripping within 10~30ms 1680A: Tripping within 6ms
Number of poles	1P/2P	3P/4P	1PN
Mechanical life	20000	20000	10000

4.4 Tripping Characteristic Curve

● NDB2Z-63/NDB2Z-63 (PV)

Type B 6 In (1 ± 20%)

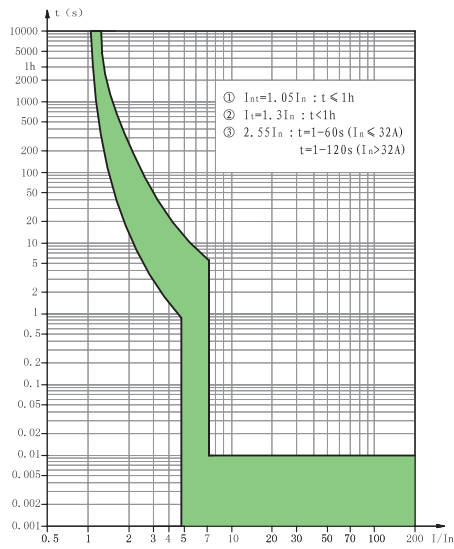

Type C 12In (1 ± 20%)

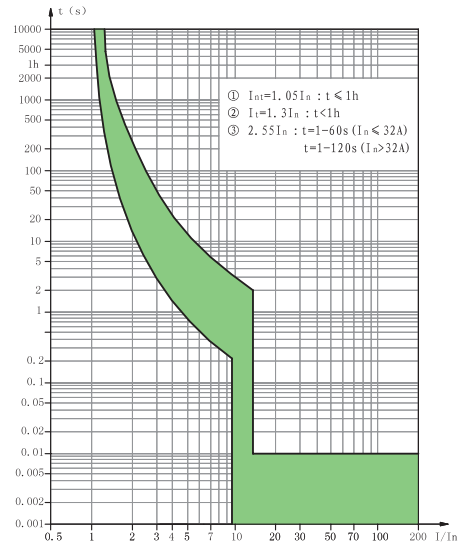

● NDB2ZB-40

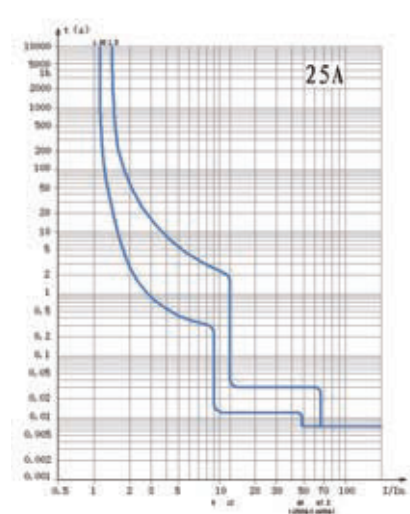
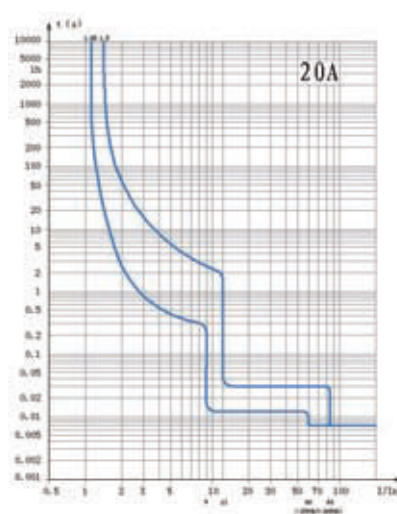
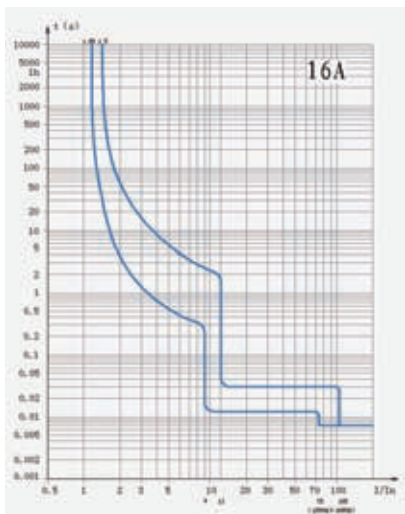

5. Accessories

OF2 auxiliary contact



SD2 alarm contact



MX + OF2 shunt tripper



NDB2Z-63/NDB2Z-63(PV) accessories forms

Serial No.	Name	Accessory code	Function and number of loading
1	Auxiliary contact	OF2	Loaded on the left side of a circuit breaker to indicate the On/Off state of the circuit breaker; 3 can be loaded at most
2	Alarm contact	SD2	Loaded on the left side of a circuit breaker to indicate the fault tripping state of the circuit breaker; 3 can be loaded at most
3	Shunt tripper	MX+OF2	Loaded on the left side of a circuit breaker to indicate the fault tripping state and remote breaking control of the circuit breaker;

Note: For details of accessory parameters, see “OF2, SD2 and MX+OF2” samples

6. Outline and Installation Dimension

6.1 NDB2Z-63 Outline Dimension

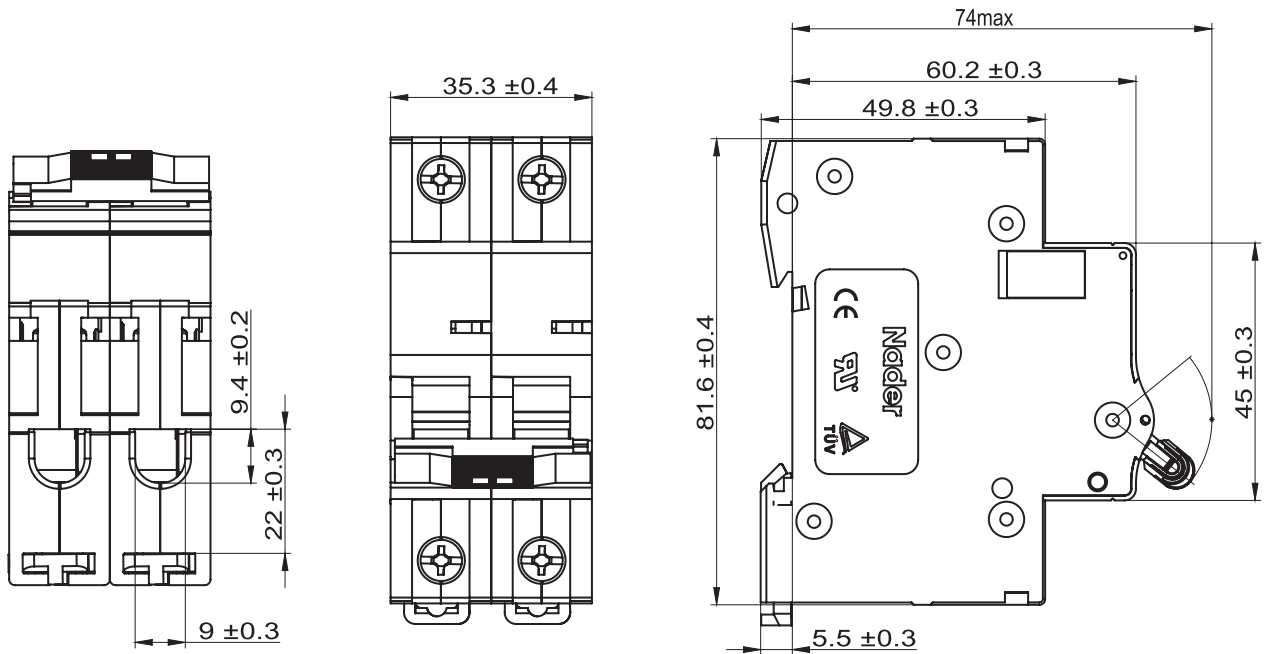

6.2 NDB2Z-63 (PV) Outline Dimension

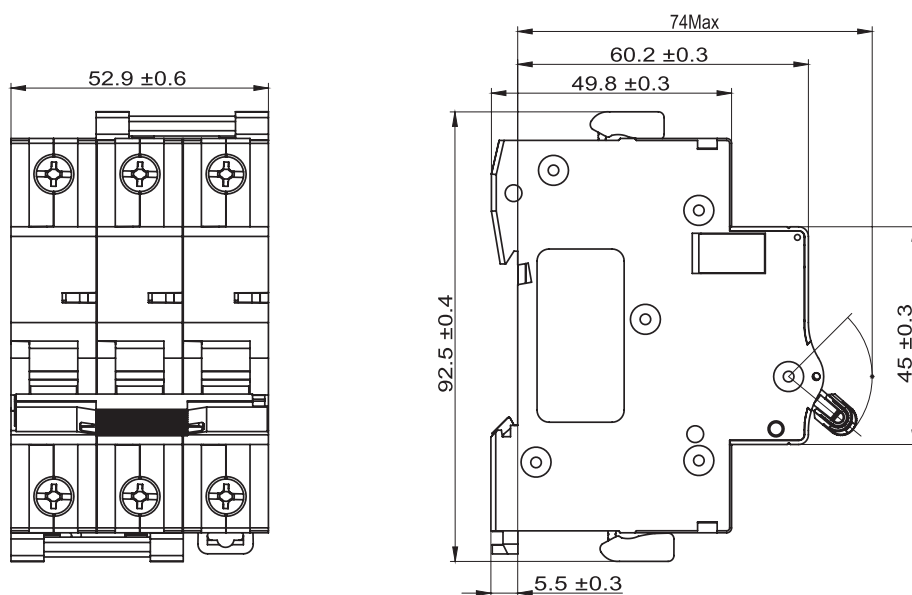

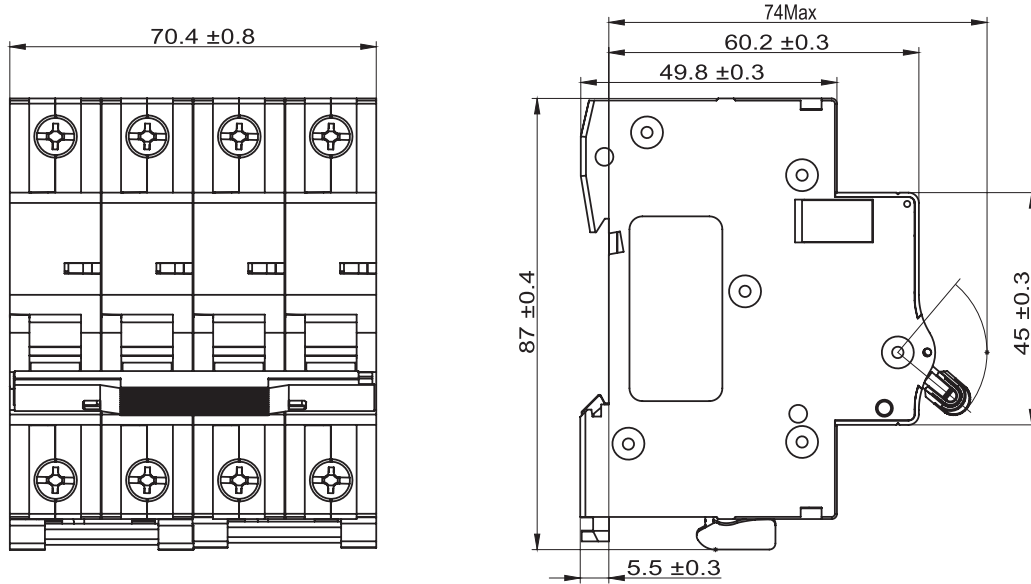

4P

6.3 NDB2ZB-40 Outline Dimension

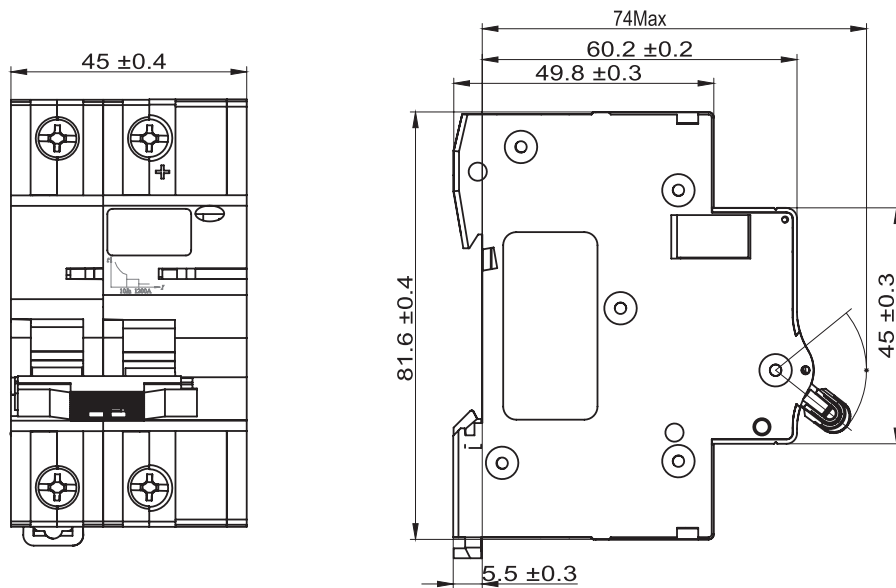

7. Electric Circuit Diagram

● NDB2Z-63

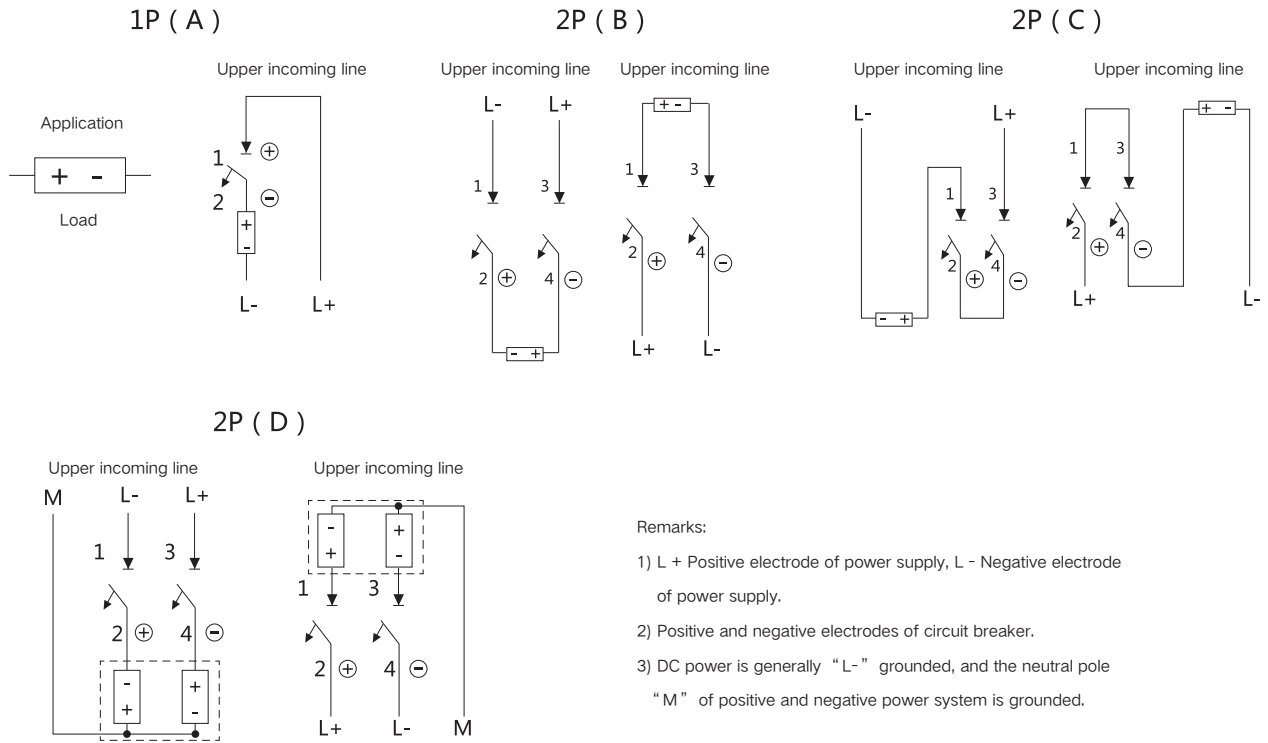

● NDB2Z-63(PV)

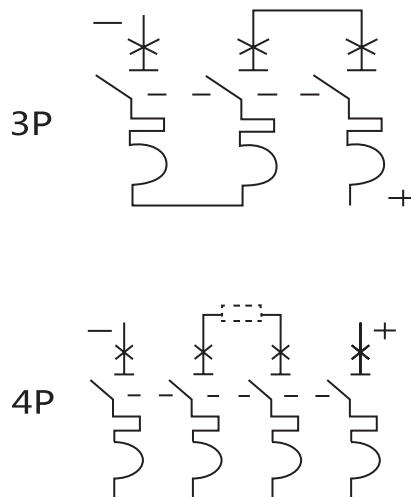

● NDB2ZB-40

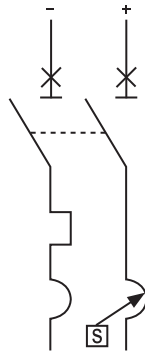

8. Specifications for Ordering and Selection (Tick ✓ in)

User unit		Number of units ordered:	Date of order:
Specifications	<input type="checkbox"/> NDB2Z-63	<input type="checkbox"/> NDB2ZB-63(PV)	<input type="checkbox"/> NDB2ZB-40
Rated current	1A、2A、3A、4A、6A、8A、10A、13A、16A、20A、25A、32A、40A、50A、63A、		10A、16A、20A、25A、32A、40A
Tripping type	<input type="checkbox"/> B、 <input type="checkbox"/> C	<input type="checkbox"/> B、 <input type="checkbox"/> C	<input type="checkbox"/> B、 <input type="checkbox"/> C、 <input type="checkbox"/> D
Number of poles	<input type="checkbox"/> 1P、 <input type="checkbox"/> 2P、 <input type="checkbox"/> 3P、 <input type="checkbox"/> 4P	<input type="checkbox"/> 3P、 <input type="checkbox"/> 4P	<input type="checkbox"/> 1PN

Note: The accessories must be ordered separately. For details, see “Configuration of standard accessories” .

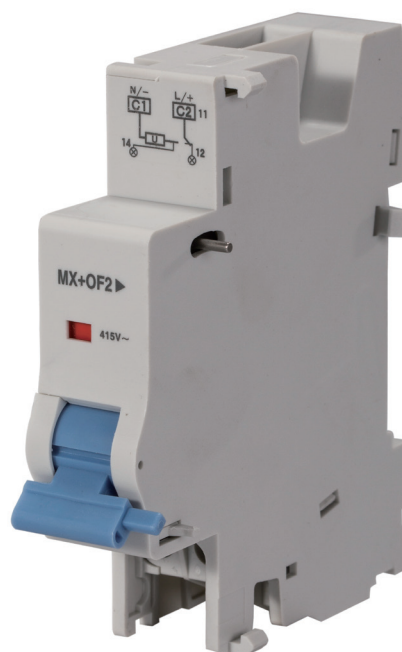

OF2、SD2、NFS2、MX+OF2、 NGQ2A、ATM、TM2 Accessories

Edition 2016

1. Product Overview

				
Specifications	OF2 auxiliary contact	SD2 alarm contact	NFS2 auxiliary and alarm contact group	MX + OF2 shunt tripper
Material number	30000354	30000503	30001722	30000367
Adaptation	NDB2-63 NDB2Z-63 NDB2ZB-40 NDB2T-63 NDB2LE-63	NDB2-63 NDB2Z-63 NDB2ZB-40 NDB2T-63 NDB2LE-63	NDB2-63 NDB2Z-63 NDB2ZB-40 NDB2T-63 NDB2LE-63	NDB2-63 NDB2Z-63 NDB2ZB-40 NDB2T-63 NDB2LE-63

			
Specifications	NGQ2A overvoltage and under-voltage accessories	ATm reclosing control accessories	Tm2 remote control accessories
Material number	30001743	30000501	
Material number	NDB2-63 NDB2Z-63 NDB2ZB-40 NDB2T-63 NDB2LE-63	NDB2-63 NDB2Z-63 NDB2T-63 NDB2LE-63	NDB2-63 NDB2Z-63 NDB2T-63 NDB2LE-63

2. Scope of Application

This series of accessories can be assembled in the terminal NDB2 products, and are used for the circuits with AC 50Hz, rated voltage of AC415V and below and DC130V and below. They have a wide range of applications in the low-voltage terminal power distribution equipment in such fields as industry, civil construction, energy, communication and infrastructure.

● Installation way

TH35mm standard installation rail for installation.

● Installation direction

- ◆ Horizontal installation
- ◆ Vertical installation

● Environmental protection requirements

Products meet the RoHS standard.

3. Technical Characteristics of the Product

3.1 OF2 Auxiliary Contact

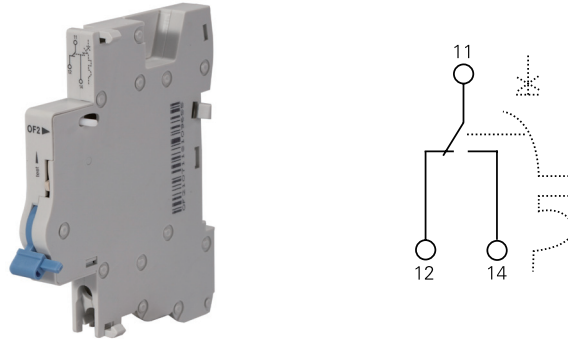

● Purpose

Installed on the left side of NDB2 miniature circuit breaker to indicate the On/Off state of the circuit breaker.

● Technical parameters

Rated working parameters

	Voltage	Current		Voltage	Current
AC	415V	3A	AC	240V	6A
DC	250V	0.4A	DC	220V	1A
DC	130V	1A	DC	110V	1A
DC	48V	6A	DC	24V	6A

Density (mm): 9.

Note:

After assembled with the NDB2 circuit breaker, terminals 11 and 14 are connected at the time of closing.

At the time of opening, terminals 11 and 12 are connected.

3 OF2 can be assembled at most.

3.2 SD2 Alarm Contact

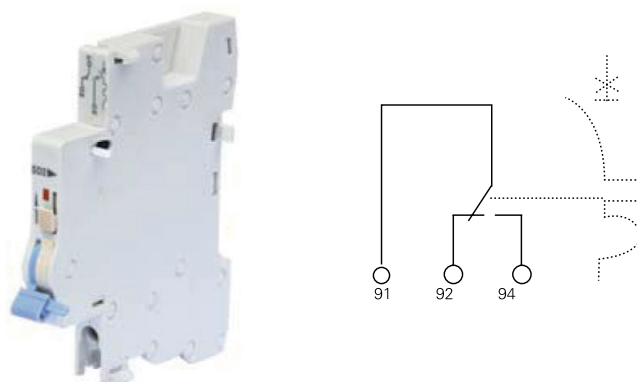

● Purpose

Installed on the left side of NDB2 miniature circuit breaker to indicate the fault state of the circuit breaker.

● Technical parameters

Rated working parameters

	Voltage	Current		Voltage	Current
AC	415V	3A	AC	240V	6A
DC	250V	0.4A	DC	220V	1A
DC	130V	1A	DC	110V	1A
DC	48V	6A	DC	24V	6A

Density (mm): 9.

Note:

After assembled with the NDB2 circuit breaker, terminals 91 and 92 are connected at the time of closing.

At the time of fault opening, 91 and 94 are connected.

At the time of manual opening, 91 and 92 are connected, but 91 and 94 are not.

3 SD2 can be assembled at most.

● Purpose

- ◆ Single line: 2.5mm²; Double line: 1.5mm².
- ◆ NDB2 series miniature circuit breaker accessories can be supplied separately, but are not recommended to be used in conjunction with the miniature circuit breakers of other companies.

3.3 NFS2 Auxiliary and Alarm Contact Group

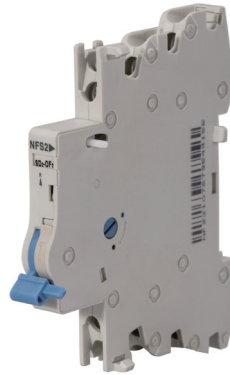

● Rated current of the auxiliary contact

Rated operational voltage	Rated operating current	Use class
AC 240V	6A	AC 12
AC 415V	3A	AC 12
DC 24V	6A	DC 12
DC 48V	2A	DC 12
DC130V	1A	DC 12

● Purpose

- ◆ NFS2 auxiliary and alarm contact group is assembled on the left side of NDB2-63 series products, and the secondary products can be switched between OF2+SD2 and OF2+OF2 mainly by use of a selective switch.
- ◆ Highlight: The functions of OF2 and SD2 are integrated as one, with the width as a module.

● Two switching contacts may indicate

- ◆ “On” or “Off” state of the circuit breaker can be indicated by use of OF2-OF2;
- ◆ “Fault tripping” of circuit breaker.

● Two return circuits

- ◆ Upper: OF2-OF2;
- ◆ Lower: SD2 or OF2;
- ◆ Rotary switch on the right is used to rotate.

● Wiring

- ◆ Thread lug terminal may be connected with 1 or 2 wires with the maximum cross-section of 2.5mm²;
- ◆ There is an obvious mark next to the terminal.

3.4 MX+OF2 Shunt Tripper

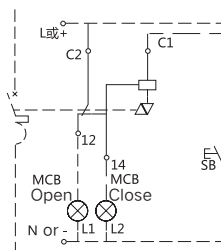

● Purpose

- ◆ Installed on the left side of NDB2-63 miniature circuit breaker;
- ◆ Remote control of circuit breaker tripping.

● Technical parameters

- ◆ Control power supply AC230V/400VDC24V/48V;
- ◆ Width (mm) : 18

Note: The changeover contact is an active contact and is not allowed to connect other weak current modules as a passive contact.

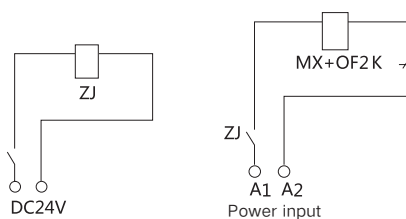

Note: In case of DC24V power supply for control circuit, the shunt control circuit is recommended to be designed according to the figure above.

ZJ: DC24V intermediate relay, with the contact current capacity of 1A.

● Wiring capacity

- ◆ Single line: 2.5mm²
- ◆ Double line: 1.5mm²
- ◆ This accessory can be supplied separately, but is not recommended to be used in conjunction with the miniature circuit breakers of other companies.

● Technical parameters

- ◆ Control power supply AC230V/400VDC24V/48V;
- ◆ Width (mm) : 18

3.5 NGQ2A Overvoltage and Under-voltage Tripper

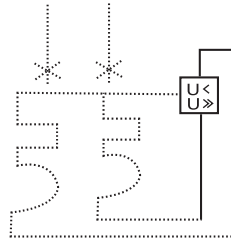

● Purpose

- ◆ Installed on the left side of NDB2-63 miniature circuit breaker to provide single-phase overvoltage, under-voltage, overvoltage and under-voltage protection.

● Technical parameters

- ◆ Rated overvoltage operating value U_{over} : AC280V \pm 12V, maximum breaking time: 0.2s;
- ◆ Rated under-voltage operating value U_{under} : AC170V \pm 7V, maximum breaking time: 1s.

Density (mm): 18。

Note:

The user may only choose overvoltage tripper (NG2A) or under-voltage tripper (NQ2A) as needed.

Each circuit breaker can only be assembled with one under-voltage tripper to provide single-circuit protection.

3.6 ATm Reclosing Control Accessory



● Application scope and purpose

ATm reclosing control accessory (ATm for short) is installed on the left side of Tm2 remote control accessory, and assembled with SD2 for use in return circuit with voltage of AC230V (-15%+10%) and frequency of 50~60Hz to

provide reclosing of circuit breaker after fault action. It is particularly suitable for the equipment and systems that are difficult to monitor and access and have high power supply continuity requirements.

● Technical parameters

- ◆ Operating voltage: AC230V
- ◆ Normally open output contact: 2A (maximum), load of Class AC1
- ◆ ATm must be used in combination with Tm remote control accessories through SD2 alarm contacts, and SD2 is used to send “fault tripping” signal to ATm.
- ◆ ATm operation is associated with fault type (temporary fault/permanent fault). When a temporary fault occurs and is eliminated, ATm allows the circuit breaker to be automatically closed. In case of a permanent fault, ATm will lock Tm2 remote control accessories to avoid re-closing of the circuit breaker.
- ◆ The front panel of ATm has a transparent cover, and the front panel includes:
 - ★ A selective switch
 - ★ It is marked with the allowable times of reclosing of circuit breaker (0, 1, 2, 5 or 10) and ATm off/reset
 - ★ Rotary knob T1 is used to set the maximum duration to complete the given times of reclosing (12~120min)
 - ★ Rotary knob T2 is used to set the delay time of automatic reclosing (30~300s)
 - ★ ATm status indicator lamp (Yellow)
 - ※ Not on: Not energized or at the off/reset state
 - ※ Quick flash: Normal operation
 - ※ Slow flash: Reclosing state
 - ※ Normally on: Locked state
- ◆ ATm can also achieve the following functions:
 - ★ Inputting remote control signal to ATm by connecting a selective switch or changeover contact so that ATm is at the safe mode state, i.e., the same as the “0” state of selective switch on the front panel
 - ★ Remote indication that Tm2 is locked.
- ◆ At the time of manual control of Tm2 (namely, no fault signal), ATm setting will not work
- ◆ During the reclosing process, if the remote control accessory Tm2 fails to close the circuit breaker in place within 3 seconds, there may be the risk of short circuit in the secondary circuit, which will be deemed as permanent fault, lock Tm2, and prohibit reclosing.
- ◆ Wiring: Flexible cable (2X1.5mm² or 1X2.5mm²) hard cable (2X2.5mm²)

3.7 Tm2

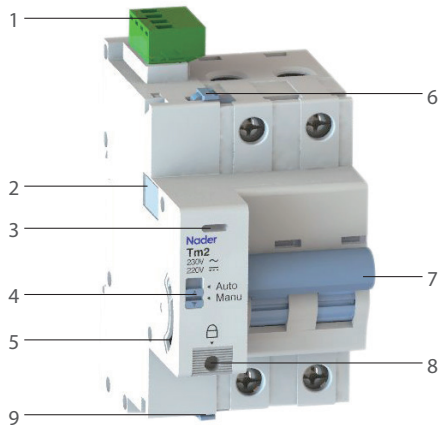

- 1. Power supply control input terminal
- 2. Alarm accessory interface
- 3. Power indication lamp
- 4. Manual and automatic switching button
- 5. Auxiliary accessory interface
- 6. Buckle
- 7. Handle
- 8. Opening padlock
- 9. Snap spring



Legend	
Auto	Remote close-open circuit breaker
Manu	Local close-open circuit breaker



Legend	
Padlock	Disconnect all remote operations, padlock size $\Phi \leq 4\text{mm}$



Legend	
Alarm accessory interface	Assembly model SD2
Auxiliary accessory interface	Assembly model OF2

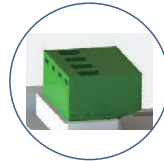

Legend	
Socket type terminal	Maximum wiring capacity of ports 1~4 is 2.5mm ² (24-14AWG) and wiring capacity 0.56N•m

Remarks:

1. After the assembly of Tm2 and circuit breaker body, assemble other accessories;
2. The left side of Tm2 can be assembled with 2 SD2 or 2 OF2 or 1 SD2, 1 OF2

● Technical parameters

Parameter name	Description of specific parameters									
Number of poles	1P/2P					3P/4P				
Width (mm)	18					27				
Control voltage (V)	AC230/ DC220	AC110/ DC110	DC48	DC24	DC12	AC230/ DC220	AC110/ DC110	DC48	DC24	DC12
Start power consumption (W)	46	33	48	36	36	46	33	48	36	36
Operating current (A)	≤0.2	≤0.3	≤1	≤1.5	≤3	≤0.2	≤0.3	≤1	≤1.5	≤3
Insulation voltage (V)	500					500				
Closing or opening time (s)	≤0.5					≤0.5				
Operating life (Times)	20000					20000				
Protection grade	IP20					IP20				
Models which can be assembled	NDB2-63/1P、NDB2Z-63/1P、 NDB2T-63/1P、NDB2LE-63/1PN					NDB2-63/3P、NDB2Z-63/3P、 NDB2T-63/3P、NDB2LE-63/3P				
	NDB2-63/2P、NDB2Z-63/2P、 NDB2T-63/2P、NDB2LE-63/2P					NDB2-63/4P、NDB2Z-63/4P、 NDB2T-63/4P、NDB2LE-63/3PN /4P				
Weight (g)	107					123				

4. Outline and Installation Dimension

4.1 OF2, SD2 Outline Dimension

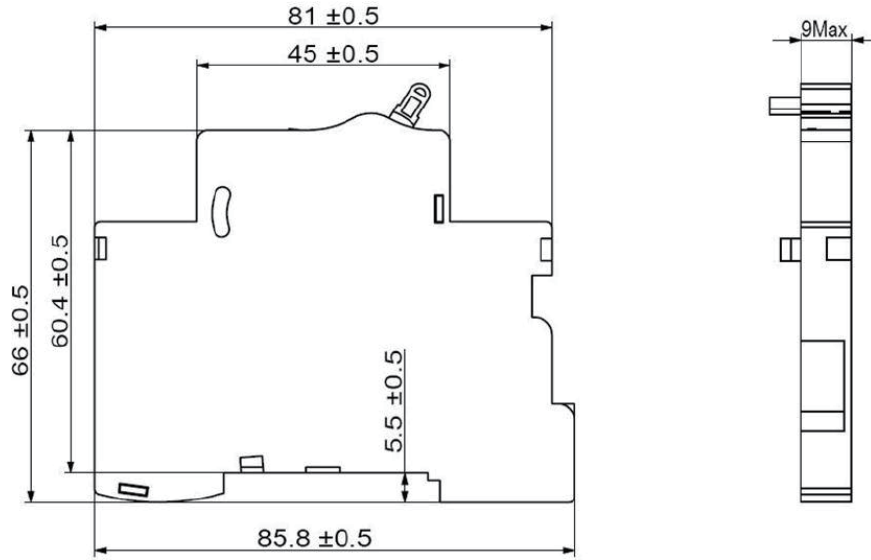

4.2 NFS2 Outline Dimension

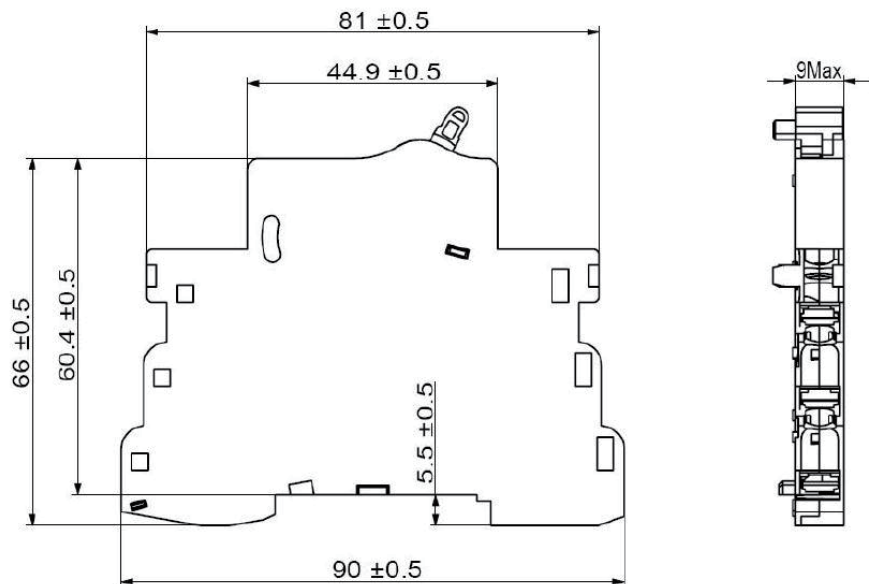

4.3 MX+OF2, NGQ2A Outline Dimension

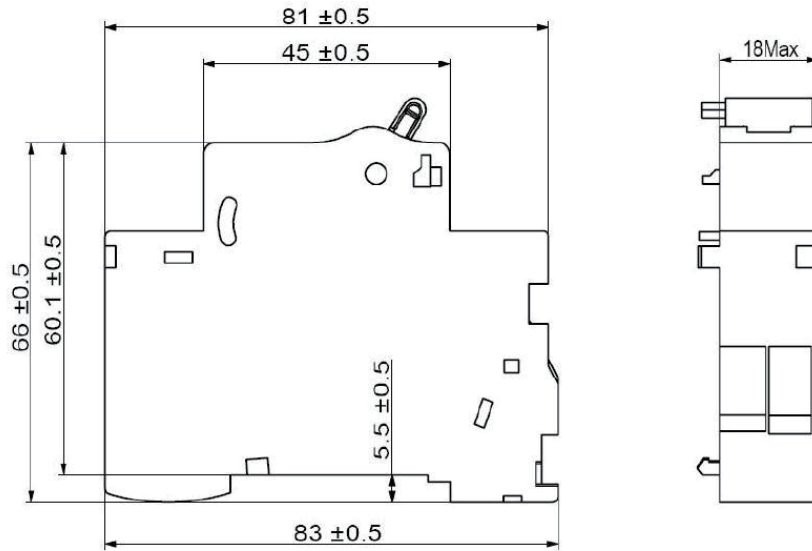

4.4 ATm Outline Dimension

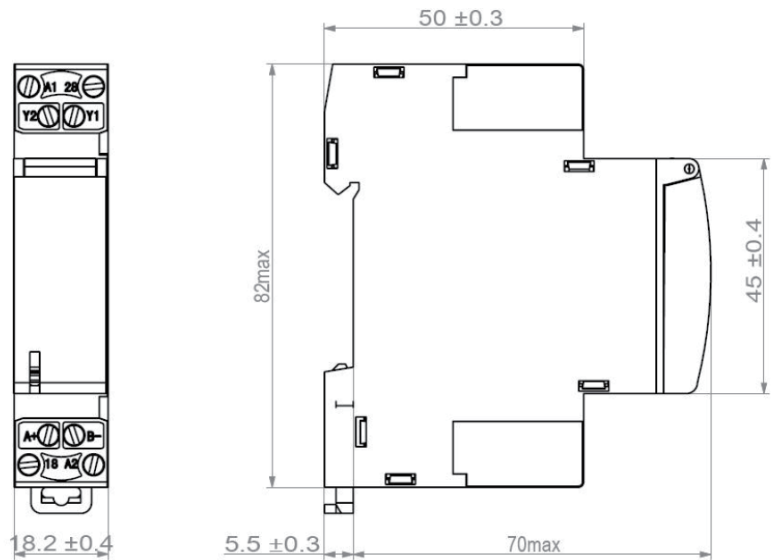

4.5 Tm2 Outline Dimension

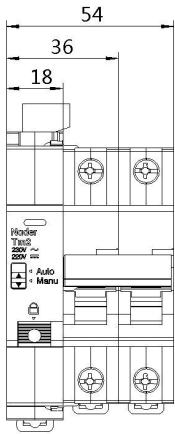

1P/2P

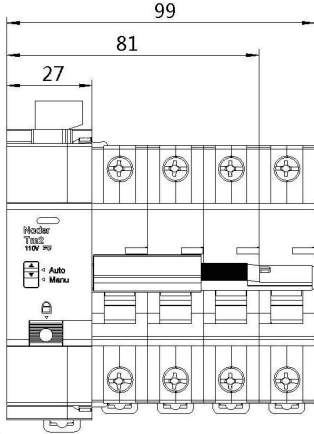

3P/4P

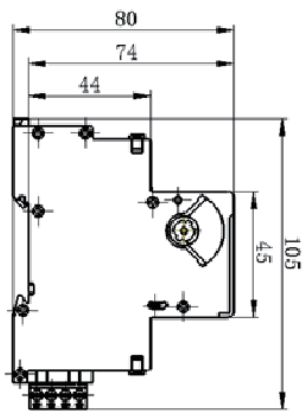

1/2/3/4P Side view

5. Product Wiring Diagram

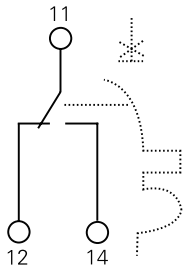

OF2

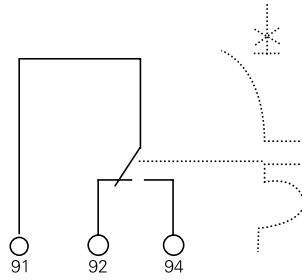

SD2

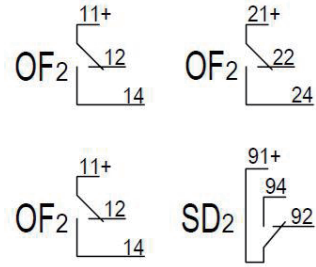

NFS2

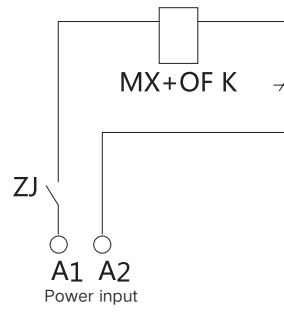
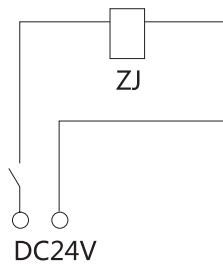

MX+OF2

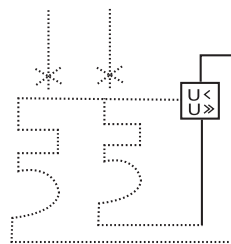

NGQ2A

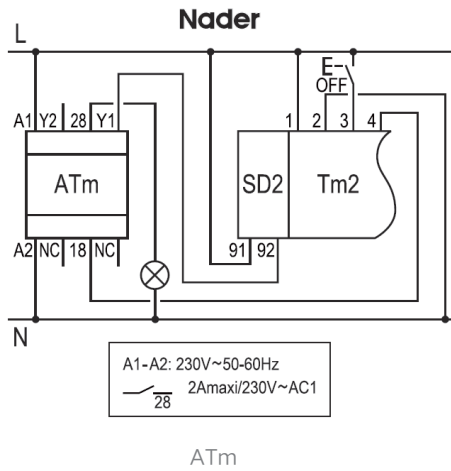

Wiring terminal	Function description
A1-A2	AC 230 (50~60HZ)
Y1	Input: SD2 contact signal
Y2	Input: Use normally open contact and disable ATm
18	Output: Remote control Tm2
28	Output: Remote indication that Tm2 is locked.
NC(A+)	Reserved terminal
NC(B-)	Reserved terminal

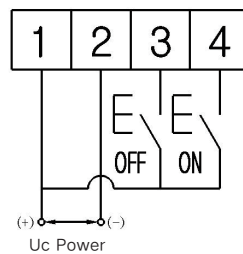

Note: When the power supply is DC, the negative and positive electrodes cannot be reversed;
When the power supply is AC, the positive and negative electrodes may be freely wired

6. Specifications for Ordering or Selection

Warranty period of product: Prepare normative selection table according to the provided selection data.

User unit		Number of units ordered:	Date of order:
Frame grade	<input type="checkbox"/> OF2 <input type="checkbox"/> SD2 <input type="checkbox"/> NFS2 <input type="checkbox"/> MX+OF2 <input type="checkbox"/> ATm <input type="checkbox"/> Tm2		
Voltage AC/DC	OF2: <input type="checkbox"/> 01 SD2: <input type="checkbox"/> 02 NFS2: <input type="checkbox"/> 03 MX+OF2: <input type="checkbox"/> 04 (AC48V) <input type="checkbox"/> 05 (AC240V) <input type="checkbox"/> 06 (AC415V) <input type="checkbox"/> 07 (DC24V) <input type="checkbox"/> 08 (DC48V) ATm: <input type="checkbox"/> 09 Tm2: <input type="checkbox"/> 11 (AC110) <input type="checkbox"/> 12 (AC230) <input type="checkbox"/> 13 (DC12) <input type="checkbox"/> 14 (DC24) <input type="checkbox"/> 15 (DC48) <input type="checkbox"/> 11 (DC110) <input type="checkbox"/> 12 (DC220)		
Type	<input type="checkbox"/> ATm normal <input type="checkbox"/> ATm for communication		
Installation mode	<input type="checkbox"/> Guide rail installation		
Number of poles	Tm2: <input type="checkbox"/> 1P <input type="checkbox"/> 2P <input type="checkbox"/> 3P <input type="checkbox"/> 4P		



Tm2 Series Electric Operating Mechanism

Edition 2016

Nader

1. Product Overview

Picture				
Specifications	Tm2/1P	Tm2/2P	Tm2/3P	Tm2/4P
Adaptation	NDB2-63/1P NDB2Z-63/1P NDB2T-63/1P NDB2LE-63/1PN	NDB2-63/2P NDB2Z-63/2P NDB2T-63/2P NDB2LE-63/2P	NDB2-63/3P NDB2Z-63/3P NDB2T-63/3P NDB2LE-63/3P	NDB2-63/4P NDB2Z-63/4P NDB2T-63/4P NDB2LE-63/3PN/4P

<div style="display: flex; justify-content: space-around; align-items: center;"> <div style="text-align: center;"> Tm 1 </div> <div style="text-align: center;"> 2 / □ / □ 2 3 4 </div> </div>		
Serial No.	Description of serial number	Code explanation
1	Product code	Remote control
2	Design serial No.	2
3	Voltage specification	12、24、48、110、230
4	Number of poles	1、2、3、4

2. Scope of Application

- ◆ Accessories of NDB2-63, NDB2Z-63, NDB2T-63 and NDB2LE-63 series products
- ◆ Mainly used for communication, transportation, new energy, intelligent control and other fields requiring remote control

3. Application Scope

3.1 Installation way

Install with TH35mm standard installation rail, tunnel type wiring terminal used for wiring

3.2 Installation direction

360° installation, flexible installation direction

3.3 Environmental protection requirements

Products meet the RoHS standard

3.4 Altitude requirements

≤ 4000m

3.5 Humidity and heat resistance

Alternating hot and humid (At the temperature of +55°C, the relative humidity is 95%)

3.6 Working environment

-25 ~ +70°C

3.7 Pollution class

3

3.8 Other extensions (Legend)

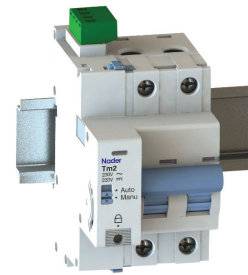

35mm standard guide rail installation

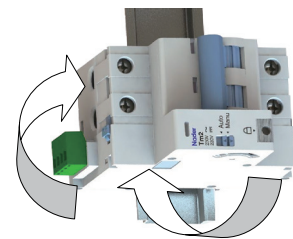

360° installation

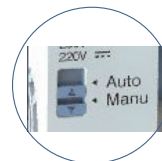
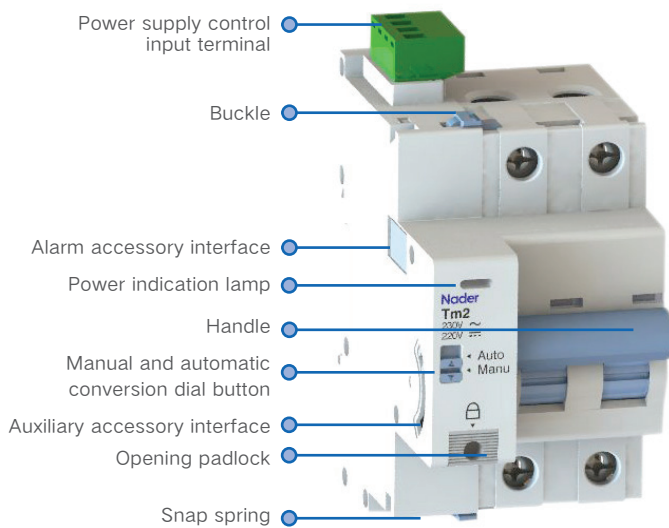

Legend

Auto	Remote close-open circuit breaker
Manu	Local close-open circuit breaker



Legend

Padlock	Disconnect all remote operations, padlock size $\Phi \leq 4\text{mm}$
----------------	---



Legend

Alarm accessory interface	Assembly model SD2
Auxiliary accessory interface	Assembly model OF2

Remarks:

1. After the assembly of Tm2 and circuit breaker body, assemble other accessories;
2. The left side of Tm2 can be assembled with 2 SD2 or 2 OF2 or 1 SD2, 1 OF2
3. Tm2 can be assembled with SD2 and ATm to reclose the circuit breaker after fault

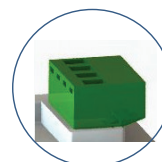

Legend

Socket type terminal	Maximum wiring capacity of ports 1~4 is 2.5mm ² (24-14AWG) and wiring capacity 0.56N·m
-----------------------------	---

4. Technical Characteristics of the Product

4.1 Purpose

- ◆ For return circuits with control voltages of DC12V, DC24V, DC48V, DC110V, DC220V, AC110V and AC230V, provide remote closing/breaking control of circuit breakers
- ◆ Handle can be used to provide local control of circuit breakers
- ◆ Padlock accessory can be used to lock the opening of circuit breaker, thus ensuring safe operation on the site

4.2 Technical parameters

Parameter name	Description of specific parameters									
Number of poles	1P/2P					3P/4P				
Width (mm)	18					27				
Control voltage (V)	AC230/ DC220	AC110/ DC110	DC48	DC24	DC12	AC230/ DC220	AC110/ DC110	DC48	DC24	DC12
Start power consumption (W)	46	33	48	36	36	46	33	48	36	36
Operating current (A)	≤0.2	≤0.3	≤1	≤1.5	≤3	≤0.2	≤0.3	≤1	≤1.5	≤3
Insulation voltage (V)	500					500				
Closing or opening time (s)	≤0.5					≤0.5				
Operating life (Times)	20000					20000				
Protection grade	IP20					IP20				
Models which can be assembled	NDB2-63/1P、NDB2Z-63/1P、 NDB2T-63/1P、NDB2LE-63/1PN					NDB2-63/3P、NDB2Z-63/3P、 NDB2T-63/3P、NDB2LE-63/3P				
	NDB2-63/2P、NDB2Z-63/2P、 NDB2T-63/2P、NDB2LE-63/2P					NDB2-63/4P、NDB2Z-63/4P、 NDB2T-63/4P、NDB2LE-63/3PN/4P				
Weight (g)	107					123				
Mechanical shock resistance	Half-wave sine pulse peak acceleration: 300m/s ² ; shock pulse period: 11ms; 3 shocks									
Vibration resistance	Frequency range: 10~150Hz; acceleration: 3g									

5. Outline and Installation Dimension

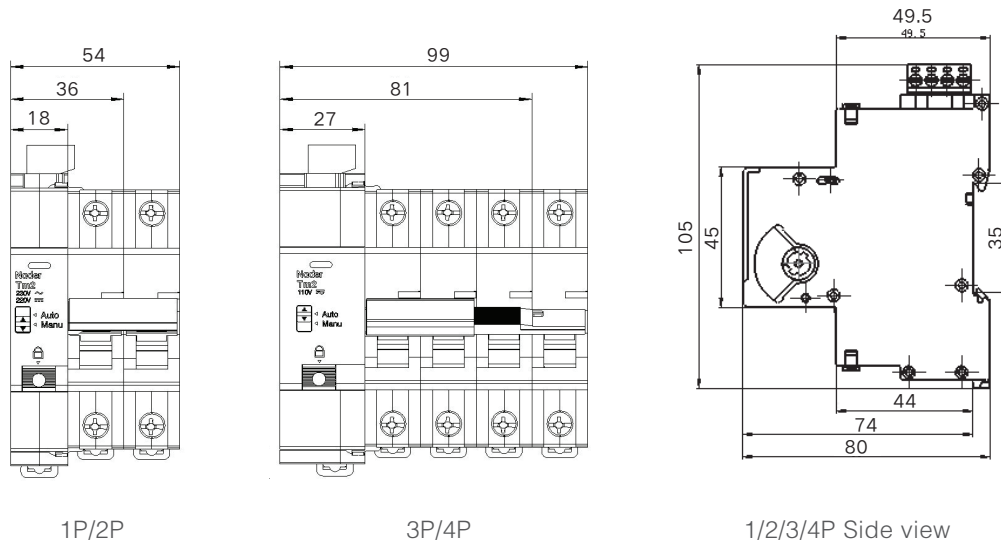

6. Product Wiring Diagram

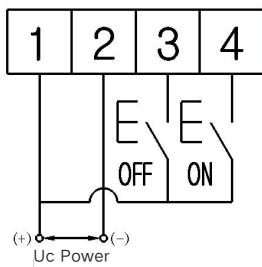

Note: When the power supply is DC, the negative and positive electrodes cannot be reversed;

When the power supply is AC, the positive and negative electrodes may be freely wired

7. Package and Storage

The existing NDB2LE-63 packaging crates, boxes and plastic bags of our company are used for packaging. The products in packaging boxes should be stored in the warehouse where air circulation and relative humidity are less than 80% and temperature is neither higher than 60°C nor lower than -25°C. And the warehouse should be free from acidic, alkaline or other corrosive gases in the ambient air. Under the above-mentioned conditions, the storage period is not more than three years from the date of production.

8. Matters Needing Attention

- ◆ The product must be installed by the personnel with professional qualification. The body of the product may not be disassembled without the permission of the manufacturer. Quality problems caused by unauthorized disassembly of the product should be at your own risk.
- ◆ Do not touch the product when it is powered on to avoid any possible electric shock event.
- ◆ In case of tripping of circuit breaker due to possible fault of protection circuit (overload or short circuit), it is a must to switch the electric operating mechanism to the manual status, find out the causes, eliminate the fault and restore to the automatic status.
- ◆ In case of normal maintenance or troubleshooting of load side line, the electric operating mechanism must also be returned to the manual status first.
- ◆ Please do not debug the product without permission. Any product quality problems incurred therefrom will not be the responsibility of the manufacturer.



Tm2GQ Overvoltage and Under-voltage Auto-reclosure Accessory

Edition 2016

Nader

1. Product Overview

Picture		
Specifications	Tm2GQ/2P	Tm2GQ/4P
Adaptation	NDB2-63/2P NDB2T-63/2P NDB2LE-63/2P	NDB2-63/4P NDB2T-63/4P NDB2LE-63/4P

Tm	2	GQ / <input type="checkbox"/>
1	2	3 4
Serial No.	Description of serial number	Code explanation
1	Product code	Remote control
2	Design serial No.	2
3	Product code	Overvoltage and under-voltage protection
4	Number of poles	2、4

2. Scope of Application

- ◆ NDB2-63, NDB2Z-63, NDB2T-63, NDB2LE-63 series product accessories
- ◆ Mainly applicable to low-voltage power distribution lines for household and similar uses with AC rated frequency of 50/60Hz and rated voltage of 230V and 400V (the voltage relative to neutral line is 230V)

3. Application Scope

3.1 Installation way

Install with TH35mm standard installation rail, tunnel type wiring terminal used for wiring

3.2 Installation direction

360° installation, flexible installation direction

3.3 Environmental protection requirements

Products meet the RoHS standard

3.4 Altitude requirements

≤2000m

3.5 Relative humidity for operation

When the temperature is above +40°C and the relative humidity of the air is not more than 50%, a higher relative humidity is allowed at a lower temperature. For example, the relative humidity can reach 90% at 20°C. Special measures should be taken to deal with occasional condensation due to temperature change

3.6 Working environment

-25~+60 °C, without impact vibration or rain and snow invasion

3.7 Pollution class

3

3.8 Other extensions (Legend)

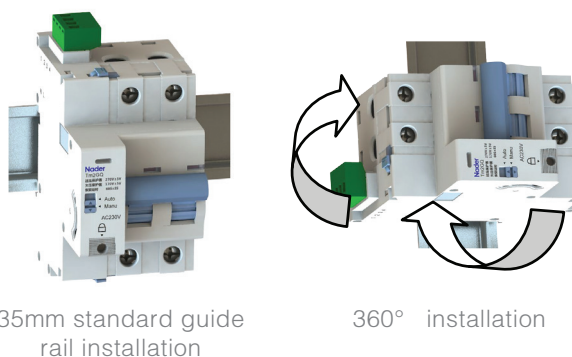

35mm standard guide rail installation

360° installation

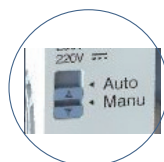
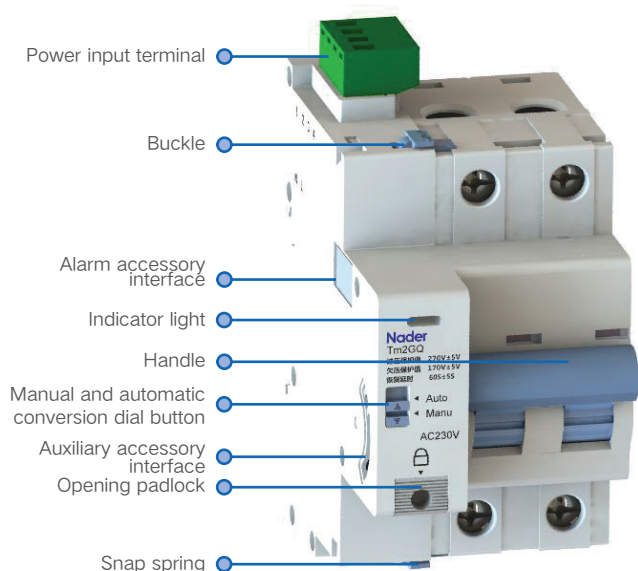

Legend

Auto	Automatically detect the line voltage; in case of overvoltage or under-voltage, the product will open; when the voltage returns to normal, the product will close after delay of 60s; if the product opening is due to the circuit breaker's protective tripping, the product will not automatically reclose and manual closing is required.
Manu	Manual opening/closing products. When line voltage anomalies appear, the product will not operate.

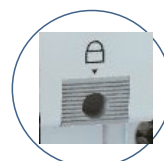

Legend

Padlock	At the state of opening, it may be locked; after locking, the product will not be closed. Padlock size $\Phi \leq 4\text{mm}$.
----------------	---



Legend

Alarm accessory interface	Assembly model SD2
Auxiliary accessory interface	Assembly model OF2

Remarks:
 1. Only after the assembly of Tm2GQ and circuit breaker body will other accessories be assembled;
 2.The left side of Tm2GQ can be assembled with 2 SD2 or 2 OF2 or 1 SD2, 1 OF2

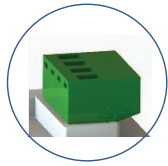

Legend	
Socket type terminal	Maximum wiring capacity of ports 1~4 is 2.5mm ² (24-14AWG) and wiring capacity 0.56N·m



Legend	
Indicator light	Green on permanently: Normal operation, closing state Red on permanently: Under-voltage fault Red flash: Overvoltage fault Green flash: Delayed closing Orange on permanently: Fault lockout Indicator light off: No power or \\[manual/automatic] switch is at the manual state

4. Technical Characteristics of the Product

4.1 Purpose

- ◆ For low-voltage power distribution lines for household and similar uses with control voltages of AC230V and AC400V (the voltage relative to neutral line is 230V), it is used to automatically detect the line voltage, automatically disconnect the faulty line in case of line overvoltage and under-voltage, and automatically close when the line voltage returns to normal range to ensure the safe operation of load equipment under normal voltage
- ◆ Handle can be used to realize manual operation of circuit breaker
- ◆ Padlock accessory can be used to lock the opening of circuit breaker, thus ensuring safe operation on the site

4.2 Technical parameters

Parameter name	Description of specific parameters	
Number of poles	2P	4P
Width (mm)	18	27
Rated voltage (V)	AC230V	AC400V
Assemblable circuit breaker model	NDB2-63/2P、NDB2T-63/2P、NDB2LE-63/2P	NDB2-63/4P、NDB2T-63/4P、NDB2LE-63/4P
Weight (g)	109	146
Rated impulse withstand voltage (kV)	4	
Under-voltage protection value (V)	170 ± 5 (phase voltage)	
Overvoltage protection value (V)	270 ± 5 (phase voltage)	
Under-voltage recovery value (V)	190 ± 5 (phase voltage)	
Overvoltage recovery value (V)	250 ± 5 (phase voltage)	
Self-recovery closing delay (s)	60 ± 5	
Closing or opening time (s)	≤0.5	
Operating life (times)	10000	
Protection grade	IP20	

5. Outline and Installation Dimension

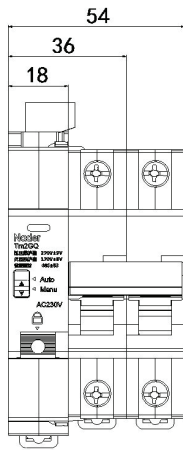

2P

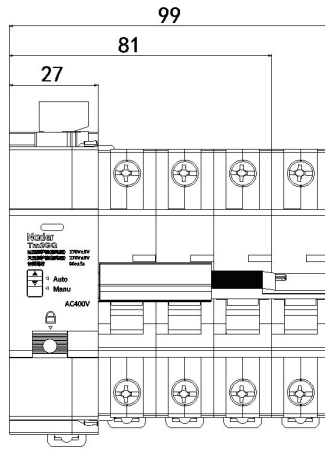

4P

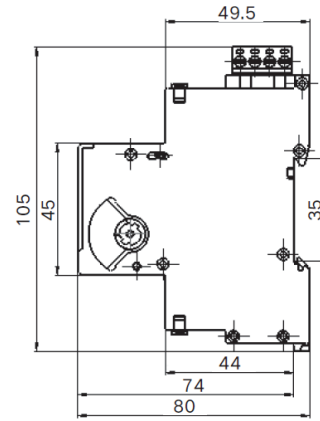

1/2/3/4P Side view

6. Product Wiring Diagram

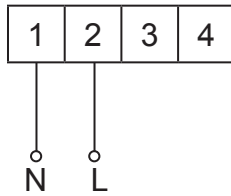

Tm2GQ/2P

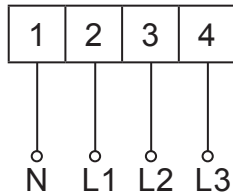

Tm2GQ/4P

Note: L and N wiring cannot be reversed

7. Package and Storage

The existing NDB2LE–63 packaging crates, boxes and plastic bags of our company are used for packaging. Products in packaging boxes should be stored in the warehouse where air circulation and relative humidity are less than 80% and temperature is neither higher than +60°C nor lower than –25°C. And the warehouse should be free from acidic, alkaline or other corrosive gases in the ambient air. Under the above–mentioned conditions, the storage period is not more than three years from the date of production.

8. Matters Needing Attention

- ◆ The product must be installed by the personnel with professional qualification. The body of the product may not be disassembled without the permission of the manufacturer. Quality problems caused by unauthorized disassembly of the product should be at your own risk.
- ◆ Do not touch the product when it is powered on. Do not operate the device with wet hands to avoid any possible electric shock event.
- ◆ In case the product is at the automatic mode, it will not automatically reclose if the circuit breaker opens manually or the fault switch trips due to load, except for automatic action due to voltage fault; it is a must to manually/automatically switch the rotary knob of overvoltage and under–voltage auto–reclosure accessory to the manual mode first, and then find out the causes, eliminate the faults, close manually to reset, and manually/automatically switch the rotary knob to the automatic mode.
- ◆ During normal maintenance or troubleshooting of load side line, it is required to make sure that the overvoltage and under–voltage auto–reclosure accessory returns to the manual mode first.
- ◆ Please do not debug the product without permission. Any product quality problems incurred therefrom will not be the responsibility of the manufacturer.

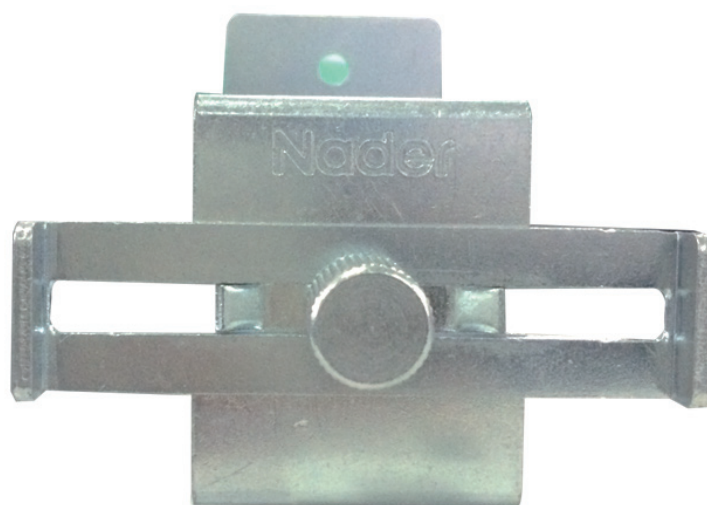

JS1-11Y/B2-63 Mechanical Interlock

Edition 2016

Nader

1. Product Overview

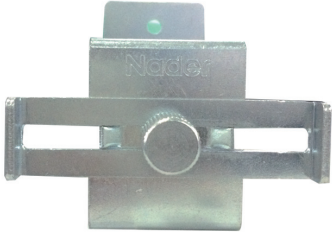
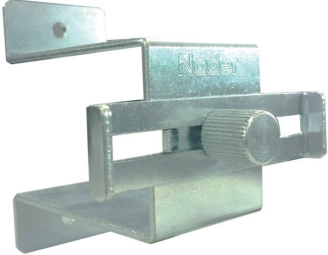
Picture		
Adaptation	NDB2-63 NDM1-63 NDM1-125	

JS <u>1</u>	1 - 11 <u>2</u> <u>3</u>	Y - B2-63 <u>4</u>	B2-63 <u>5</u>
Serial No.	Description of serial number	Description	
1	Product code	Mechanical interlock	
2	Design serial No.	1	
3	Opening/closing state	One closing and one opening	
4	Connection category	Hard wiring	
5	Body model	Without ND	

Instructions on No. 5: In order to meet the Company's model naming rules, it is required to add the body model to the end.

For specific applicable product model, see the table above

2. Scope of Application

- ◆ NDB2-63, NDM1-63, and NDM1-125 series product accessories
- ◆ Mainly applicable to the fields where two circuit breakers are required for mechanical interlock control

3. Application Scope

3.1 Installation way

The product is assembled with the circuit breaker for use. The circuit breaker is installed by use of the standard installation rail TH35mm, and the mechanical interlock is fixed with M5 screws for installation (by the customer).

3.2 Installation direction

The product is installed according to the installation direction of the circuit breaker

3.3 Environmental protection requirements

Products meet the RoHS standard

3.4 Humidity and heat resistance

When the temperature is 55°C, relative air humidity $\leq 95\%$

3.5 Salt mist grade

72h

3.6 Other extensions (legend)

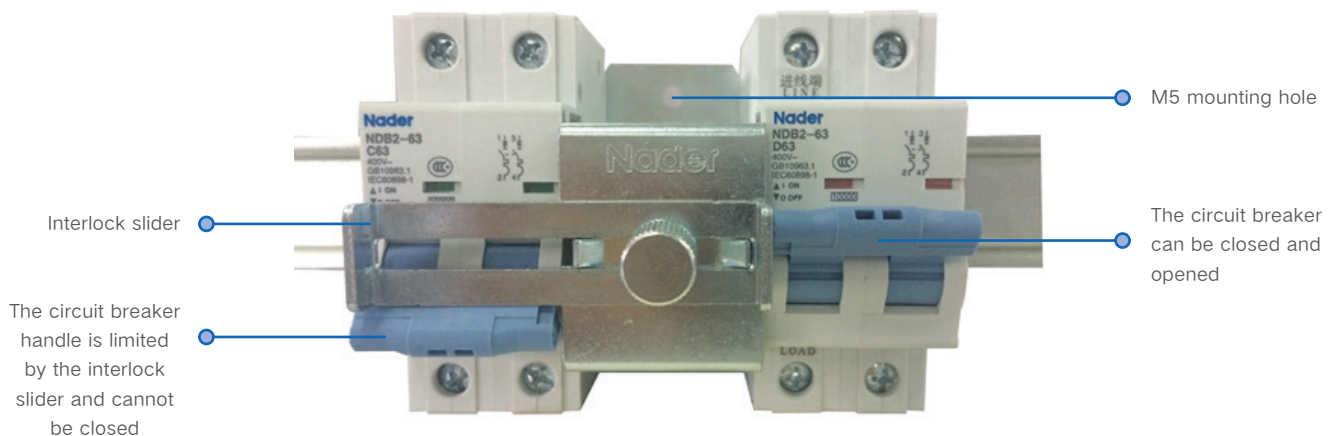

4. Technical Characteristics of the Product

4.1 Purpose

- ◆ Mainly used for mechanical interlock control of two circuit breakers to prevent them from simultaneous closing, that is, when a circuit breaker is closed, the other cannot be closed
- ◆ The assembly method of circuit breaker (2P/3P/4P) is the same as the mechanical interlock device

4.2 Technical parameters

Parameter name	Description of specific parameters
Width (mm)	36
Assemblable circuit breaker model	NDB2-63、NDM1-63、NDM1-125
Weight (g)	147

5. Outline and Installation Dimension

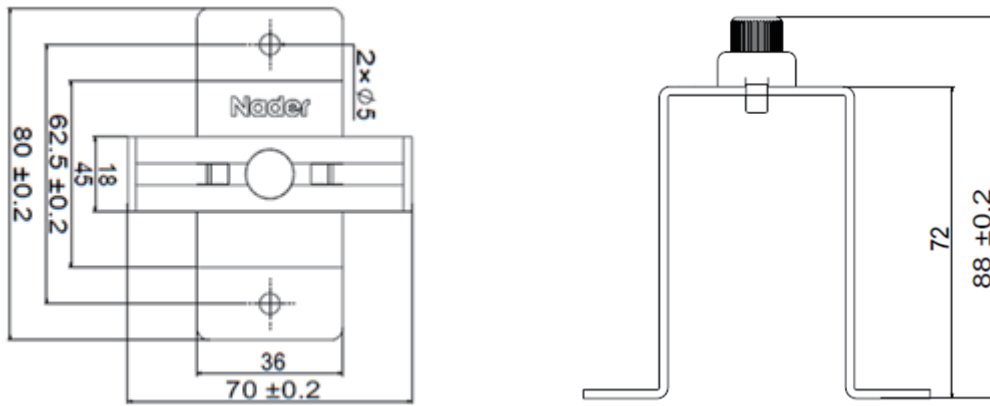

6. Package and Storage

The existing 104–CX09/18 packaging crates (16 sets/crate), boxes (1 set/box) and plastic bags of our company are used for packaging. The products in packaging boxes should be stored in the warehouse where air circulation and relative humidity are less than 80% and temperature is neither higher than +60°C nor lower than –25°C. And the warehouse should be free from acidic, alkaline or other corrosive gases in the ambient air. Under the above–mentioned conditions, the storage period is not more than 3 years from the date of production.

7. Matters Needing Attention

The circuit breaker is required to be assembled with the product without power on and the circuit breaker must be open.





NDB2LE Series Residual Current Oper- ated Circuit Breakers

Edition 2016

Nader

1. Product Overview

		
Product models	NDB2LE-25	NDB2LE-63
Rated voltage	AC230/240V	AC230/240V(1PN、2P), AC380/400/415V(3PN、3P、4P)
Rated current	10A、16A、20A、25A	1A、2A、4A、6A、10A、16A、 20A、25A、32A、40A、50A、63A
Rated residual operating current	30mA	30mA、50mA、100mA、300mA
Product certification	CCC	CCC

2. Product Features

● Scope of application and purpose

NDB2LE series residual current operated circuit breakers prevent earth leakage, direct or indirect contact electric shock and other faults, and are applicable to low-voltage terminal power distribution in such fields as industry, civil construction, energy, communication and infrastructure. They provide short-circuit protection, overload protection, leakage protection and isolation protection.

● Design features

- ◆ Design of visual window: Making the product opening/closing state clearly visible
- ◆ Auxiliary linkage mechanism: Signal output, opening and closing indication

● Structural features

- ◆ NDB2LE-25 external structural drawing

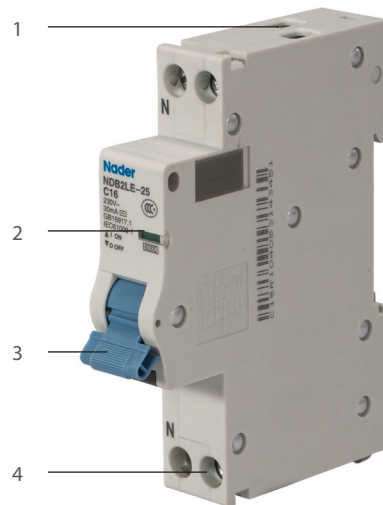

- 1: Input terminal
- 2: Status indicator lamp
- 3: Operating handle
- 4: Outgoing line terminal

- ◆ NDB2(UL489) Structures and features of the product

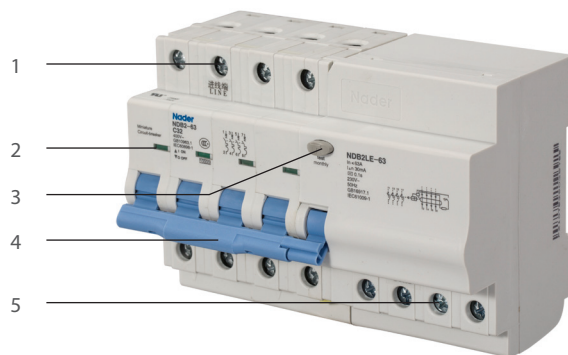

- 1: Input terminal
- 2: Status indication window
- 3: Test button
- 4: Operating handle
- 5: Outgoing line terminal

● Meeting the following standards

- ◆ GB16917.1 Residual current operated circuit breakers (RCBO) with overcurrent protection for household and similar uses - Part 1: General rules
- ◆ IEC 61009-1 Residual current operated circuit-breakers with integral overcurrent protection for household and similar uses(RCBOs)-Part 1 : General rules

3. Application Scope

● Applicable environment

- ◆ Temperature of the working environment/storage temperature
 - ★ The temperature of the working environment of NDB2LE-25 products is $-25^{\circ}\text{C}\sim+55^{\circ}\text{C}$, the benchmark setting temperature is $+30^{\circ}\text{C}$, and for different temperature correction coefficients, see Table (1).
 - ★ The temperature of the working environment of NDB2LE-63 products is $-25^{\circ}\text{C}\sim+55^{\circ}\text{C}$, the benchmark setting temperature is $+30^{\circ}\text{C}$, and for different temperature correction coefficients, see Table (2).
 - ★ Storage temperature: $-30^{\circ}\text{C} \sim +70^{\circ}\text{C}$ 。
- ◆ Altitude
Installation site altitude $\leq 2,000\text{m}$.
- ◆ Relative humidity for operation/Relative humidity for storage
The relative humidity of atmosphere is not more than 50% at the ambient air temperature of $+40^{\circ}\text{C}$; at a lower temperature, a higher relative humidity is allowed, for example, 90% at 20°C . Special measures should be taken to deal with occasional condensation due to temperature change.

● Pollution grade

2poles.

● Protection grade

Product protection grade: IP20.

● Installation way

Installed on the TH35mm \times 7.5 standard guide rail

● Installation direction

- ◆ Vertical installation, with the gradient between the installation plane and the vertical plane $\leq \pm 5^{\circ}$
- ◆ Horizontal installation.

● Environmental protection requirements

Products meet the RoHS standard.

4. Technical Characteristics of the Product

4.1 Description of specifications and models

Serial No.	Serial No. name	Code explanation	
1	Enterprise code	ND : Nader brand low-voltage apparatus	
2	Model	B : Miniature Circuit Breakers	
3	Design serial No.	2	
4	Electric leakage	L: Leakage function code (30mA)	L: Leakage function code (30mA, 50mA, 100mA, 300mA)
5	Tripper type	E: Electronic tripper	
6	Frame grade	25A	63A
7	Tripping type	C: Instantaneous tripping range 5In ~ 10In ;	B: Instantaneous tripping range 3In ~ 5In ; C: Instantaneous tripping range 5In ~ 10In ; D: Instantaneous tripping range 10In~14In;
8	Rated current	6A, 10A, 16A, 20A, 25A	1A, 2A, 4A, 6A, 10A, 16A, 20A, 25A, 32A, 40A, 50A, 63A
9	Number of poles	1PN	1PN、2P、3PN、3P、4P

4.2 Technical Parameters

Model	NDB2LE-25	NDB2LE-63
Rated voltage Ue	AC230/240V	AC230/240V(1PN、2P), AC380/400/415V(3PN、3P、4P)
Rated current In	6A、10A、16A、20A、25A	1A、2A、4A、6A、10A、16A、 20A、25A、32A、40A、50A、63A
Residual current tripper type	Type AC, electronic type	Type AC, electronic type
Rated residual operating current I _{Δn} (mA)	30	30、50、100、300
Rated insulation voltage Ui	AC500V	AC500V
Rated ultimate short-circuit breaking capacity I _{cn}	6kA	10kA
Rated running short-circuit breaking capacity I _{cs}	6kA	10kA
Rated residual making and breaking capacity I _{Δm}	500A	630A
Rated operating frequency (Hz)	50/60	50/60
Electromechanical life	10000次	10000次
Wiring mode and wiring capacity	<ul style="list-style-type: none"> ★ Tunnel type wiring terminal ★ Terminal wiring area: Applicable to (1~16) mm² wires ★ Terminal screw is M4, with torsional torque of 1.2N.m 	<ul style="list-style-type: none"> ★ Tunnel type wiring terminal ★ Terminal wiring area: Applicable to (1~35) mm² wires ★ Terminal screw is M5, with torsional torque of 2.5N.m

● Temperature correction coefficient table (1)

Ambient temperature Correction current Rated current	-35	-30	-25	-20	-15	-10	-5	-0	5	10	15
10	12.25	12.08	11.91	11.73	11.55	11.37	11.18	11.00	10.80	10.61	1.06
16	19.42	19.15	18.89	18.62	18.35	18.07	17.79	17.50	17.21	16.92	3.22
20	24.33	24.00	23.67	23.33	22.98	22.63	22.27	21.91	21.54	21.17	6.42
25	30.42	30.00	29.58	29.16	28.73	28.29	27.84	27.37	26.93	26.46	11.01

Ambient temperature Correction current Rated current	20	25	30	35	40	45	50	55	60	65	70
10	10.41	10.21	10	9.79	9.57	9.35	9.13	8.89	8.66	8.41	8.16
16	16.62	16.31	16	15.68	15.36	15.03	14.69	14.34	13.98	13.62	13.24
20	20.79	20.40	20	19.60	19.18	18.76	18.33	17.89	17.43	16.97	16.49
25	25.98	25.50	25	24.49	23.98	23.45	22.91	22.36	21.79	21.21	20.61

● Temperature correction coefficient table (2)

Ambient temperature Correction current Rated current	-35	-30	-25	-20	-15	-10	-5	-0	5	10	15
1	1.27	1.25	1.23	1.21	1.19	1.17	1.15	1.13	1.10	1.08	1.06
3	3.89	3.83	3.76	3.70	3.64	3.57	3.50	3.44	3.37	3.30	3.22
6	7.70	7.58	7.46	7.34	7.21	7.09	6.96	6.83	6.70	6.56	6.42
10	13.89	13.62	13.35	13.07	12.81	12.53	13.23	11.93	11.63	11.33	11.01
16	20.78	20.43	20.08	19.75	19.40	19.05	18.70	18.33	17.96	17.58	17.20
20	25.67	25.28	24.88	24.47	24.06	23.64	23.22	22.78	22.34	21.89	21.43
25	32.21	31.72	31.22	30.70	30.18	29.65	29.10	28.55	27.98	27.41	26.82
32	41.04	40.46	39.82	39.17	38.51	37.84	37.15	36.47	35.75	35.03	34.30
40	51.63	50.86	50.04	49.21	48.37	47.51	46.63	45.74	44.83	43.90	42.95
50	64.92	63.97	62.92	61.86	60.77	59.67	58.54	57.40	56.23	55.05	53.81
63	83.48	82.06	80.64	79.19	77.72	76.22	74.70	73.14	71.54	69.91	68.24

Ambient temperature Correction current Rated current	20	25	30	35	40	45	50	55	60	65	70
1	1.05	1.02	1.00	0.97	0.94	0.91	0.89	0.86	0.83	0.80	0.77
3	3.14	3.06	3.00	2.92	2.84	2.76	2.67	2.58	2.49	2.38	2.27
6	6.27	6.14	6.00	5.84	5.68	5.52	5.36	5.19	5.0	4.83	4.64
10	10.67	10.34	10.00	9.63	9.24	8.85	8.45	8.01	7.55	7.03	6.55
16	16.80	16.40	16.00	15.55	15.11	14.66	14.20	13.71	13.21	12.70	12.75
20	20.96	20.47	20.00	19.47	18.95	18.42	17.87	17.30	16.71	16.10	15.47
25	26.22	25.61	25.00	24.33	23.67	23.00	22.28	21.56	20.80	20.02	19.21
32	33.54	32.77	32.00	31.17	30.34	29.45	28.60	27.69	26.75	25.78	24.77
40	41.98	40.99	40.00	38.93	37.85	36.75	35.61	34.43	33.21	31.95	30.63
50	52.56	51.28	50.00	47.82	46.24	44.81	43.33	41.81	40.23	38.58	35.77
63	66.53	64.78	63.00	60.11	58.19	56.21	54.16	52.03	49.81	47.50	43.05

4.3 Product Tripping Curve

● NDB2LE-25 tripping curve

C-type curve

- ★ Protection of conventional load and power distribution cable
- ★ Rated current: 10A~25A
- ★ Tripping characteristic: Instantaneous tripping range $5I_n \sim 10I_n$

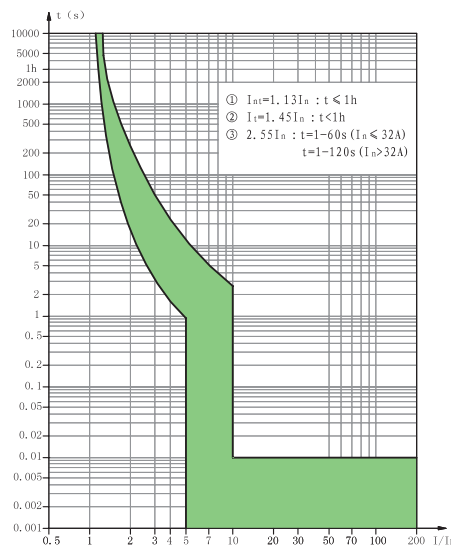

● NDB2LE-63 tripping curve

B-type curve

- ★ Protection of non-inductive or micro-inductive circuit
- ★ Rated current: 1A ~ 63A
- ★ Tripping characteristic: Instantaneous tripping range $3I_n \sim 5I_n$

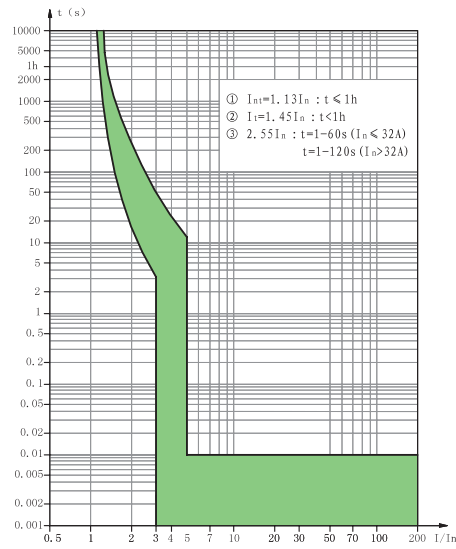

C-type curve

- ★ Protection of conventional load and power distribution cable
- ★ Rated current: 1A ~ 63A
- ★ Tripping characteristic: Instantaneous tripping range $5I_n \sim 10I_n$

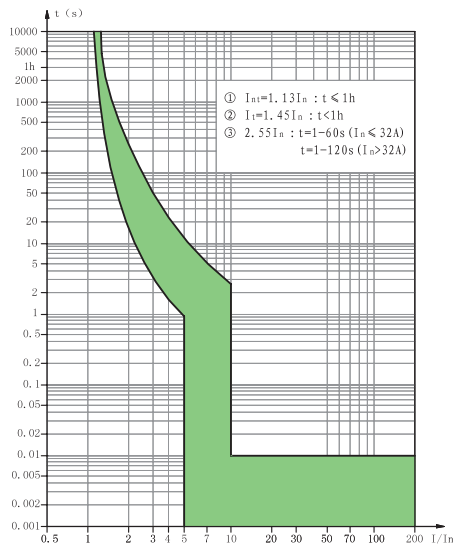

D-type curve

- ★ Protection of industrial power distribution system
- ★ Rated current: 1A ~ 63A
- ★ Tripping characteristic: Instantaneous tripping range $10I_n \sim 14I_n$

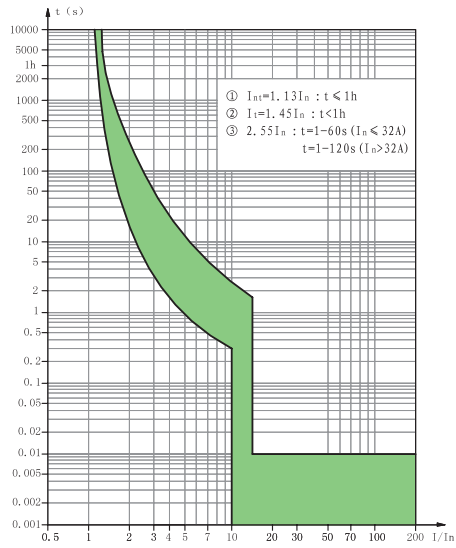

5. Accessories

● List of accessories

Auxiliary contact
OF2



Auxiliary alarm contact
NFS2



Alarm contact
SD2

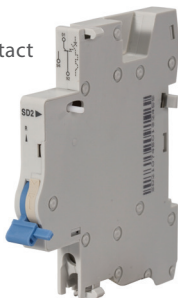

Overvoltage and
under-voltage tripper
NGQ2A



Shunt tripper
MX+OF2



● NDB2LE-63 accessories forms

Serial No.	Name	Model and specification	Function and number of loading
1	Auxiliary contact	OF2	Loaded on the left side of a miniature circuit breaker to indicate the On/Off state of the circuit breaker; 3 can be loaded at most
2	Alarm contact	SD2	Loaded on the left side of a miniature circuit breaker to indicate the fault trip state of the circuit breaker; 3 can be loaded at most
3	Shunt tripper	MX+OF2	Loaded on the left side of a miniature circuit breaker to indicate the On/Off state of the circuit breaker; 1 can be loaded at most
4	Auxiliary alarm contact	NFS2	Loaded on the left side of a miniature circuit breaker to indicate the On/Off and fault tripping state of the circuit breaker; 3 can be loaded at most
5	Overvoltage and under-voltage tripper	NGQ2A	Loaded on the left side of a miniature circuit breaker to indicate the On/Off and fault tripping state of the circuit breaker; 2 can be loaded at most

Note: For details of accessory parameters, see “OF2, SD2, MX+OF2, NFS2 and NGQ2A” samples

6. Outline and Installation Dimension

6.1 NDB2LE-25 Outline Dimension

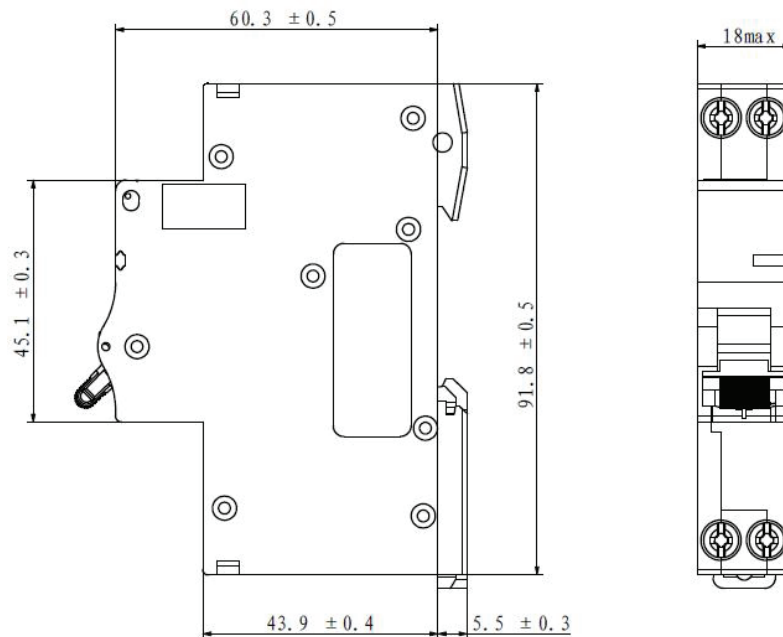

6.2 NDB2LE-63 Outline Dimension

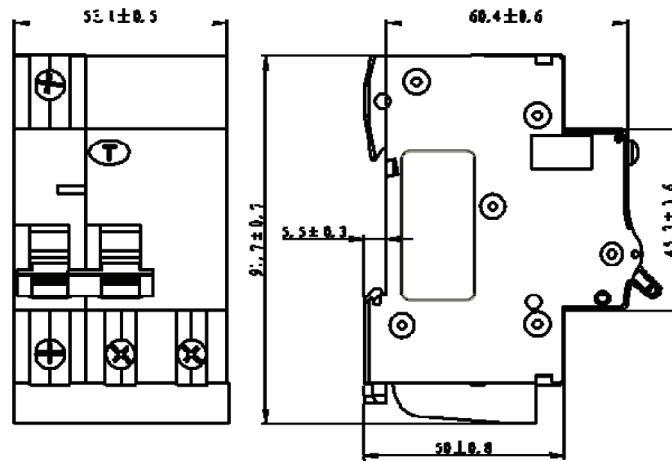

1PN

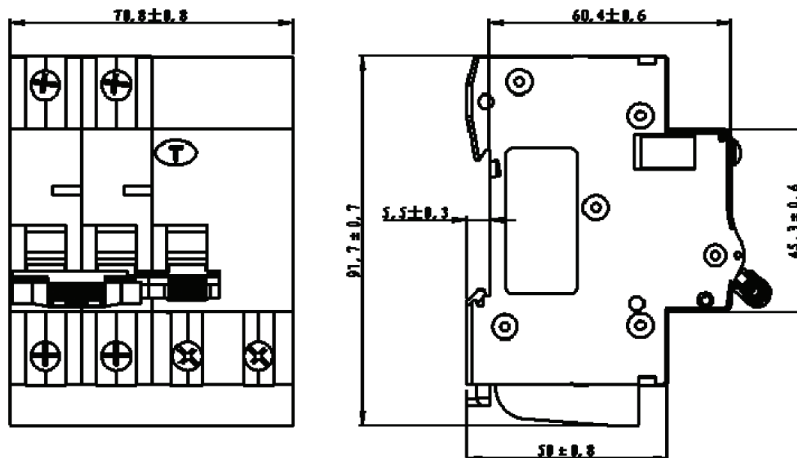

2P

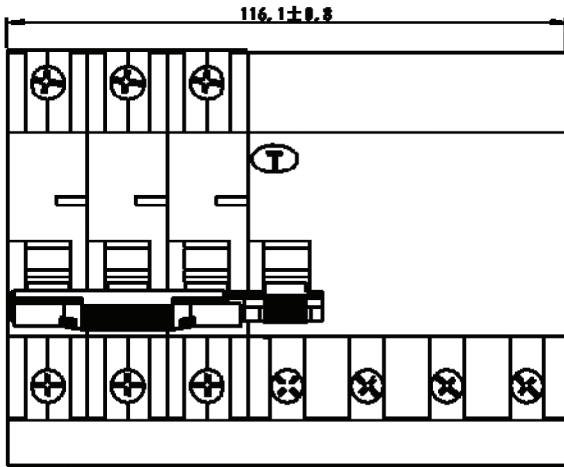

3P

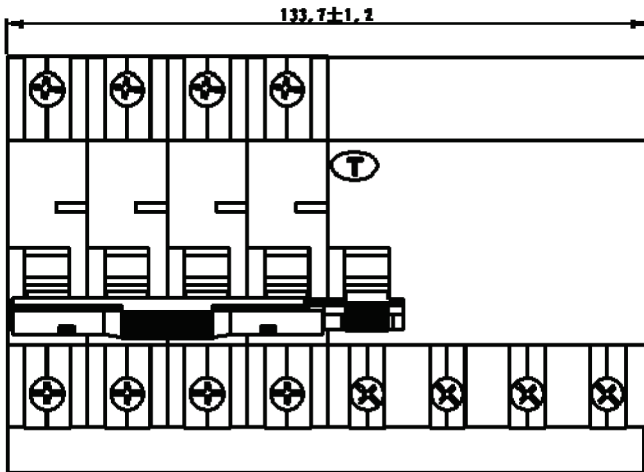
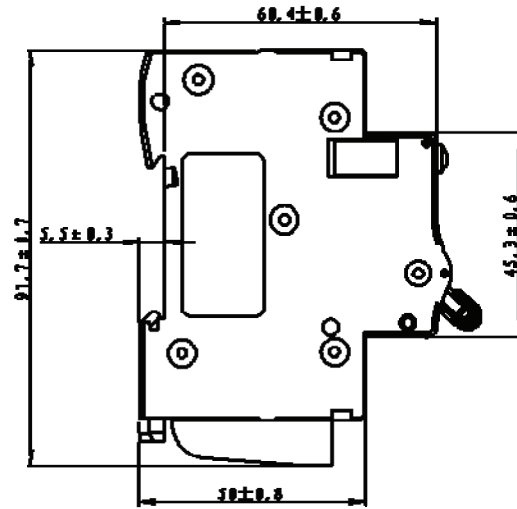

3PN

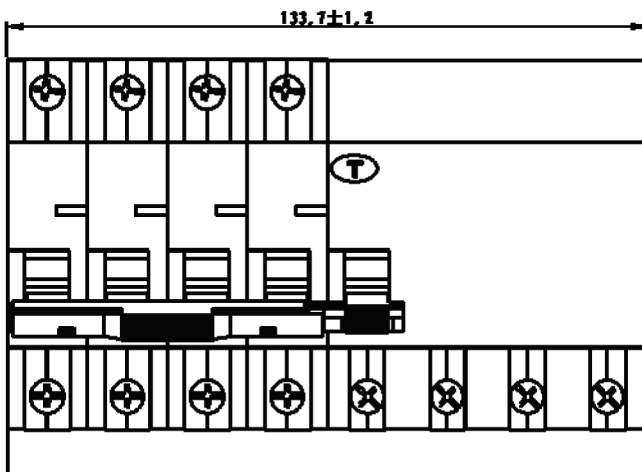
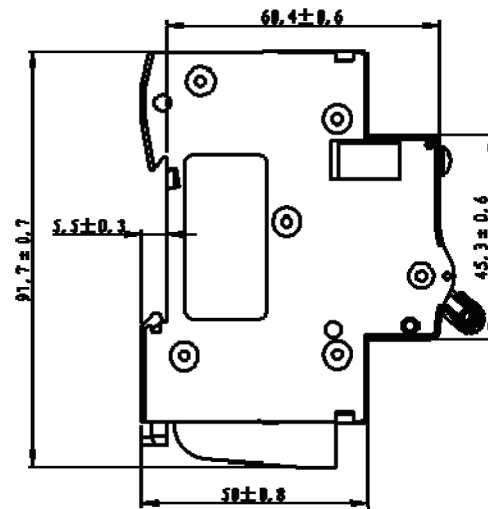

4P

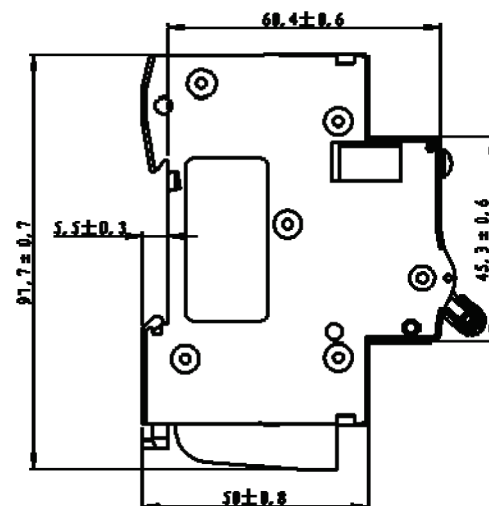

7. Electric Circuit Diagram

- N NDB2LE-25 electric circuit diagram

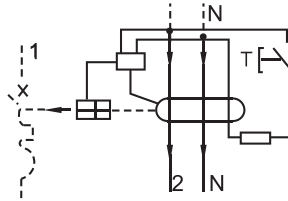

- NDB2LE-63 electric circuit diagram

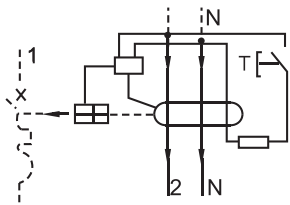

1PN electric wiring diagram

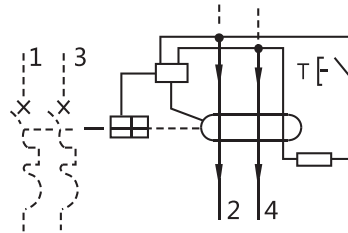

2P electric wiring diagram

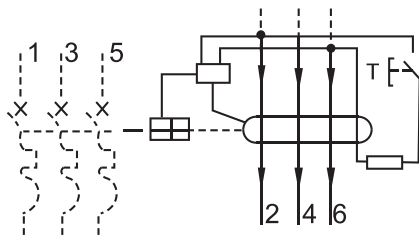

3P electric wiring diagram

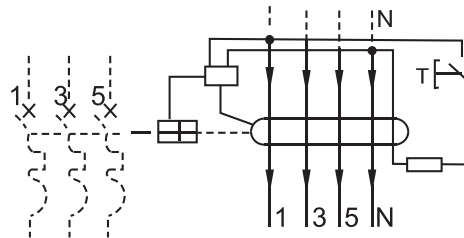

3PN electric wiring diagram

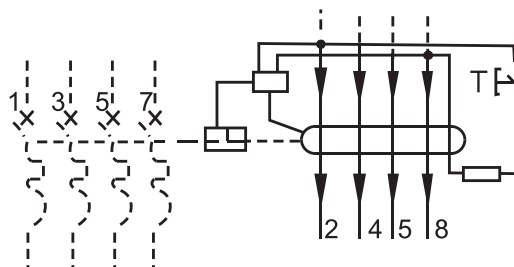

4P electric wiring diagram

8. Specifications for Ordering and Selection (Tick in)

User unit		Number of units ordered:	Date of order:
Frame grade	<input type="checkbox"/> NDB2LE-25 <input type="checkbox"/> NDB2LE-63		
Number of poles	NDB2LE-25: <input type="checkbox"/> 1PN NDB2LE-63: <input type="checkbox"/> 1PN <input type="checkbox"/> 2P <input type="checkbox"/> 3P <input type="checkbox"/> 3PN <input type="checkbox"/> 4P		
Rated operational voltage (V)	NDB2LE-25: <input type="checkbox"/> AC230/240 NDB2LE-63: <input type="checkbox"/> AC230/240 <input type="checkbox"/> AC380/400/415		
Rated operating current (A)	NDB2LE-25: 6, 10, 16, 20, 25 NDB2LE-63: 1, 2, 4, 6, 10, 16, 20, 25, 32, 40, 50, 63		
Rated residual operating current $I_{\Delta n}$ (mA)	NDB2LE-25: <input type="checkbox"/> 30 NDB2LE-63: <input type="checkbox"/> 30 <input type="checkbox"/> 50 <input type="checkbox"/> 100 <input type="checkbox"/> 300		
Tripping type	NDB2LE-25 : <input type="checkbox"/> C: The instantaneous tripping range is $5I_n \sim 10I_n$ to protect conventional load and power distribution cable NDB2LE-63 : <input type="checkbox"/> B: The instantaneous tripping range is $3I_n \sim 5I_n$ to protect non-inductive or micro-inductive circuit <input type="checkbox"/> C: The instantaneous tripping range is $5I_n \sim 10I_n$ to protect conventional load and power distribution cable <input type="checkbox"/> D: The instantaneous tripping range is $10I_n \sim 14I_n$ to protect the industrial power distribution system		