

PACKAGE DIMENSIONS

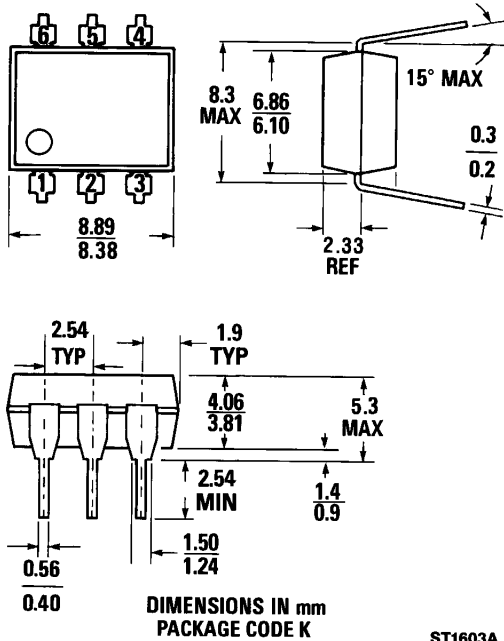

ST1603A

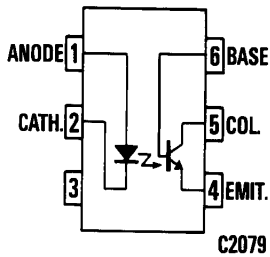

Equivalent Circuit

DESCRIPTION

The MCT2E is a NPN silicon planar phototransistor optically coupled to a gallium arsenide infrared emitting diode.

FEATURES & APPLICATIONS

- Utility/economy isolator
- AC line/digital logic isolator
- Digital logic/digital logic isolator
- Telephone/telegraph line receiver
- Twisted pair line receiver
- High frequency power supply feedback control
- Relay contact monitor
- Power supply monitor
- UL recognized — File E90700

ABSOLUTE MAXIMUM RATINGS

Storage temperature	-55°C to 150°C	Power dissipation at 25°C ambient.	200 mW
Operating temperature	-55°C to 100°C	Derate linearly from 25°C.	2.6 mW/°C
Lead soldering temperature (10 sec)	260°C	OUTPUT TRANSISTOR	
INPUT DIODE		Power dissipation at 25°C ambient.	200 mW
Forward current.	60 mA	Derate linearly from 25°C.	2.6 mW/°C
Reverse voltage.	3.0 V	Total package power dissipation at 25°C ambient	
Peak forward current		(LED plus detector)	250 mW
(1 μs pulse, 300 pps)	3.0 A	Derate linearly from 25°C.	3.3 mW/°C
		Collector-Emitter Current (I _{CE})	50 mA



PHOTOTRANSISTOR OPTOCOUPLER

ELECTRO-OPTICAL CHARACTERISTICS (25°C Free Air Temperature Unless Otherwise Specified)

INDIVIDUAL COMPONENT CHARACTERISTICS

CHARACTERISTIC	SYMBOL	MIN.	TYP.	MAX.	UNITS	TEST CONDITIONS
INPUT DIODE						
Forward voltage	V_F		1.25	1.50	V	$I_F=20\text{ mA}$
Reverse voltage	V_R	3.0	25		V	$I_R=10\text{ }\mu\text{A}$
Junction capacitance	C_J		50		pF	$V_F=0\text{ V}$, $F=1\text{ MHz}$
Reverse leakage current	I_R		.01	10	μA	$V_R=3.0\text{ V}$
OUTPUT TRANSISTOR						
DC forward current gain	h_{FE}	100	250			$V_{CE}=5\text{ V}$, $I_C=100\text{ }\mu\text{A}$
Collector to emitter breakdown volt.	BV_{CEO}	30	85		V	$I_C=1.0\text{ mA}$, $I_E=0$
Collector to base breakdown voltage	BV_{CBO}	70	165		V	$I_C=10\text{ }\mu\text{A}$, $I_E=0$
Emitter to collector breakdown voltage	BV_{ECO}	7	14		V	$I_E=100\text{ }\mu\text{A}$, $I_C=0$
Collector to emitter, leakage current	I_{CEO}		5	50	nA	$V_{CE}=10\text{ V}$, $I_E=0$
Collector to base leakage current	I_{CBO}		0.1	20	nA	$V_{CB}=10\text{ V}$, $I_E=0$
Capacitance collector to emitter	C_{CEO}		8		pF	$V_{CE}=0$
Capacitance collector to base	C_{CBO}		20		pF	$V_{CB}=10\text{ V}$
Capacitance emitter to base	C_{EBO}		10		pF	$V_{BE}=0$

TRANSFER CHARACTERISTICS

DC CHARACTERISTICS	SYMBOL	MIN.	TYP.	MAX.	UNITS	TEST CONDITIONS
DC collector current transfer ratio	CTR_{CE}	20	60		%	$V_{CE}=10\text{ V}$, $I_F=10\text{ mA}$, Note 1
DC base current transfer ratio	CTR_{CB}		.35		%	$V_{CB}=10\text{ V}$, $I_F=10\text{ mA}$
Collector-emitter, saturation voltage	$V_{CE}(\text{sat})$		0.24	0.4	V	$I_C=2.0\text{ mA}$, $I_F=16\text{ mA}$

TRANSFER CHARACTERISTICS

CHARACTERISTICS	SYMBOL	MIN.	TYP.	MAX.	UNITS	TEST CONDITIONS
SWITCHING TIMES						
Non-saturated collector						
Delay time	t_d		0.5		μS	$R_L=100\text{ }\Omega$, $I_C=2\text{ mA}$, $V_{CC}=10\text{ V}$
Rise time	t_r		2.5		μS	Fig. 10
Storage time	t_s		0.1		μS	
Fall time	t_f		2.6		μS	
Saturated collector						
Delay time	t_d		2.0		μS	$R_L=1\text{ K}\Omega$, $I_C=2\text{ mA}$, $V_{CC}=10\text{ V}$
Rise time	t_r		15		μS	
Storage time	t_s		0.1		μS	
Fall time	t_f		15		μS	

ELECTRO-OPTICAL CHARACTERISTICS (25°C Free Air Temperature Unless Otherwise Specified) (Cont'd)

TRANSFER CHARACTERISTICS (Cont'd)					
		SYMBOL	TYP.	UNITS	TEST CONDITIONS
SWITCHING TIMES (Cont'd)					
Saturated					
t on (from 5 V to 0.8 V)		t_{on} (SAT)	5	μ s	$R_L=2\text{ K}\Omega$, $I_F=15\text{ mA}$, $V_{CC}=5\text{ V}$
t off (from SAT to 2.0 V)		t_{off} (SAT)	25		$R_B=\text{open}$
Saturated					
t on (from 5 V to 0.8 V)		t_{on} (SAT)	5	μ s	$R_L=2\text{ K}\Omega$, $I_F=20\text{ mA}$, $V_{CC}=5\text{ V}$
t off (from SAT to 2.0 V)		t_{off} (SAT)	18		$R_B=100\text{ K}\Omega$
Non-saturated					
Base	Rise time	t_r	175	ns	$R_L=1\text{ K}\Omega$, $V_{CE}=10\text{ V}$
	Fall time	t_f	175	ns	
Bandwidth (see note 2)		B_w	150	KHz	$I_C=2\text{ mA}$, $V_{CE}=10\text{ V}$, $R_L=100\Omega$

ISOLATION CHARACTERISTICS						
CHARACTERISTICS	SYMBOL	MIN.	TYP.	MAX.	UNITS	TEST CONDITIONS
Steady state isolation voltage	V_{iso}	7500			VAC-PEAK	$I_{iO} \leq 1\ \mu\text{A}$, 1 minute
		5300			VAC-rms	$I_{iO} \leq 1\ \mu\text{A}$, 1 minute
Isolation resistance		10^{11}	10^{12}		Ω	$V_{iO}=500\text{ V}$
Isolation capacitance			.5		pF	F=1 MHz

TYPICAL ELECTRO-OPTICAL CHARACTERISTIC CURVES (25°C Free Air Temperature Unless Otherwise Specified)

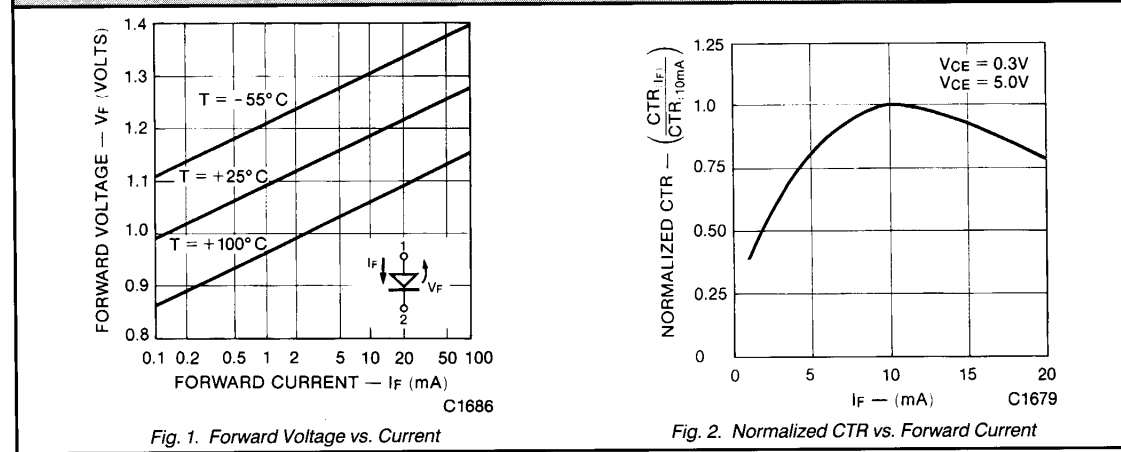

TYPICAL ELECTRO-OPTICAL CHARACTERISTIC CURVES

(25°C Free Air Temperature Unless Otherwise Specified) (Cont'd)

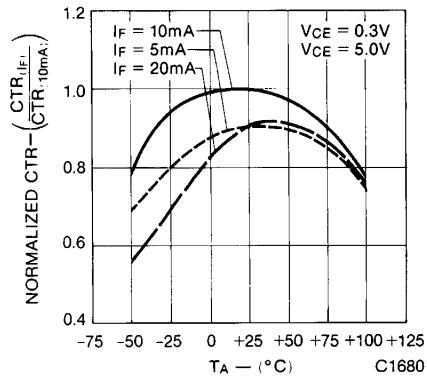

Fig. 3. Normalized CTR vs. Temperature

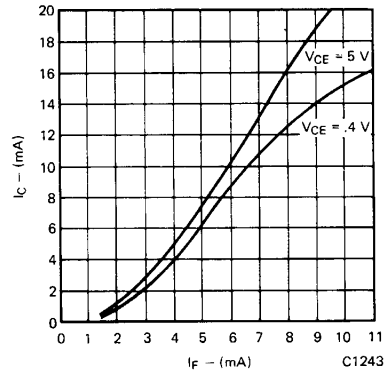

Fig. 4. Collector Current vs. Forward Current

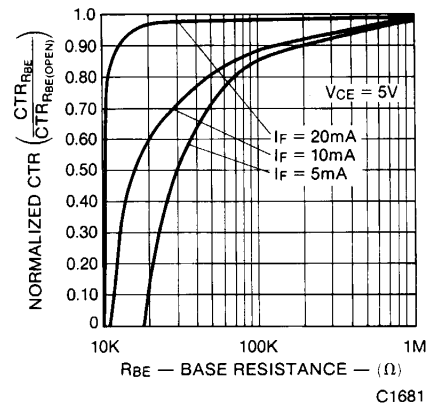

Fig. 5. CTR vs. R_{BE} (Unsaturated)

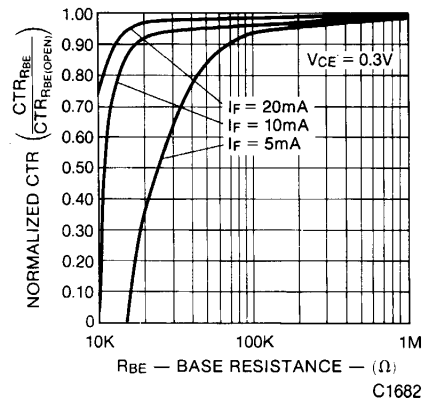

Fig. 6. CTR vs. R_{BE} (Saturated)

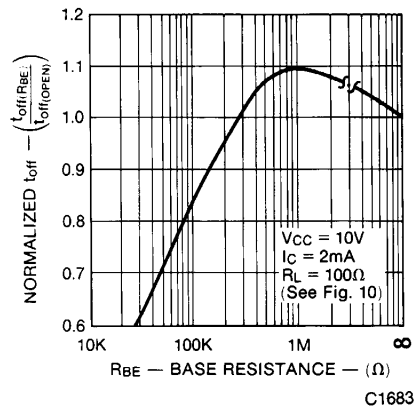

Fig. 7. Normalized T_{OFF} vs. R_{BE}

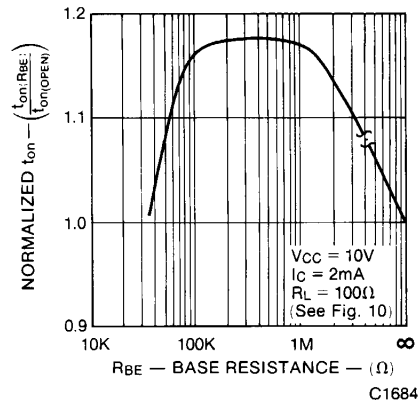

Fig. 8. Normalized T_{ON} vs. R_{BE}

TYPICAL ELECTRO-OPTICAL CHARACTERISTIC CURVES

(25°C Free Air Temperature Unless Otherwise Specified) (Cont'd)

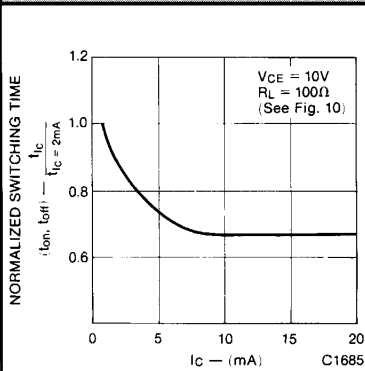

Fig. 9. Switching Time vs. IC

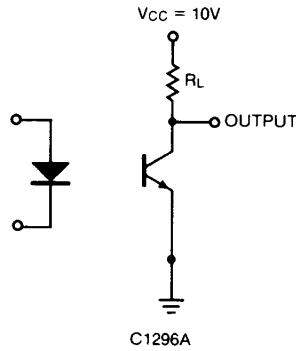

Fig. 10. Switching Time Test Circuit

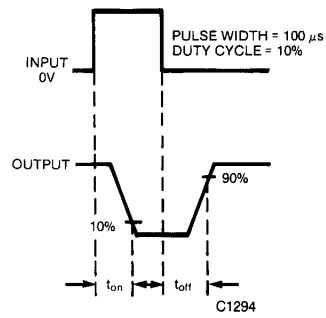
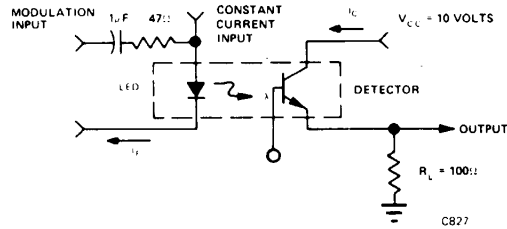

Fig. 11. Switching Time Waveforms

OPERATING SCHEMATICS



Modulation Circuit Used to Obtain Output vs. Frequency Plot

NOTES

1. The current transfer ratio (I_C/I_E) is the ratio of the detector collector current to the LED input current with V_{CE} at 10 volts.
2. The frequency at which i_c is 3 dB down from the 1 kHz value.
3. Rise time (t_r) is the time required for the collector current to increase from 10% of its final value, to 90%.
Fall time (t_f) is the time required for the collector current to decrease from 90% of its initial value, to 10%.