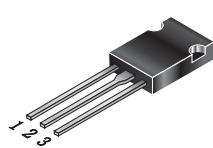

### Description

Passivated, sensitive gate triacs in a plastic envelope, intended for use in general purpose bidirectional switching and phase control applications, where high sensitivity is required in all four quadrants.

<p>Symbol</p> 		<p>Simplified outline</p>  <p>SOT-82</p>	
Pin	Description		
1	Main terminal 1 (T1)		
2	Main terminal 2 (T2)		
3	gate (G)		
TAB	Main terminal 2 (T2)		

### Applications:

- ◆ Motor control
- ◆ Industrial and domestic lighting
- ◆ Heating
- ◆ Static switching

### Features

- ◆ Blocking voltage to 600 V
- ◆ On-state RMS current to 4 A

SYMBOL	PARAMETER	Value	Unit
$V_{DRM}$	Repetitive peak off-state voltages	600	V
$I_{T(RMS)}$	RMS on-state current	4	A
$I_{TSM}$	Non-repetitive peak on-state current	25	A

SYMBOL	PARAMETER	CONDITIONS	MIN	TYP	MAX	UNIT
$R_{th(j-mb)}$	Thermal resistance Junction to mounting base	Full cycle	-	-	3.0	K/W
		Half cycle	-	-	3.7	K/W
$R_{th(j-a)}$	Thermal resistance Junction to ambient	In free air	-	100	-	K/W

### HAOPIN MICROELECTRONICS CO.,LTD.

Limiting values in accordance with the Maximum system(IEC 134)

SYMBOL	PARAMETER	CONDITIONS	MIN	Value	UNIT	
$V_{DRM}$	Repetitive peak off-state Voltages		-	600	V	
$I_{T(RMS)}$	RMS on-state current	Full sine wave; $T_{mb} \leq 107^{\circ}C$	-	4	A	
$I_{TSM}$	Non-repetitive surge peak on-state current	full sine wave;, $T_j=25^{\circ}C$ prior to surge	t=20ms	-	25	A
			t=16.7ms	-	27	A
$I^2t$	$I^2t$ for fusing	T=10ms	-	3.1	A <sup>2</sup> S	
$di_T/dt$	Repetitive rate of rise of on-state current after triggering	$I_{TM}=6A; I_G=0.2A;$ $dI_G/dt=0.2A/\mu s$	T2+G+	-	50	A/ $\mu s$
			T2+G-	-	50	A/ $\mu s$
			T2-G-	-	50	A/ $\mu s$
			T2-G+	-	10	A/ $\mu s$
$I_{GM}$	Peak gate current		-	2	A	
$V_{GM}$	Peak gate voltage		-	5	V	
$P_{GM}$	Peak gate power		-	5	W	
$P_{G(AV)}$	Average gate power	Over any 20 ms period	-	0.5	W	
$T_{stg}$	Storage temperature		-40	150	$^{\circ}C$	
$T_j$	Operating junction Temperature		-	125	$^{\circ}C$	

$T_j=25^{\circ}C$  unless otherwise stated

SYMBOL	PARAMETER	CONDITIONS	MIN	TYP	MAX	UNIT	
Static characteristics							
$I_{GT1}$	Gate trigger current	$V_D=12V; I_T=0.1A$	T2+G+	-	2.5	10	mA
			T2+G-	-	4.0	10	mA
			T2-G-	-	5.0	10	mA
			T2-G+	-	11	25	mA
$I_L$	Latching current	$V_D=12V; I_{GT}=0.1A$	T2+G+	-	3.0	15	mA
			T2+G-	-	10	20	mA
			T2-G-	-	2.5	15	mA
			T2-G+	-	4.0	20	mA
$I_H$	Holding current	$V_D=12V; I_{GT}=0.1A$	-	2.2	15	mA	
$V_T$	On-state voltage	$I_T=5A$	-	1.4	1.70	V	
$V_{GT}$	Gate trigger voltage	$V_D=12V; I_T=0.1A$ $V_D=400V; I_T=0.1A; T_j=125^{\circ}C$	-	0.7	1.5	V	
			0.25	0.4	-	V	
$I_D$	Off-state leakage current	$V_D=V_{DRM(max)}; T_j=125^{\circ}C$	-	0.1	0.5	mA	

#### Dynamic Characteristics

$dV_D/dt$	Critical rate of rise of Off-state voltage	$V_{DM}=67\% V_{DRM(max)}; T_j=125^{\circ}C;$ Exponential wave form; gate open circuit	-	50	-	V/ $\mu s$
$t_{gt}$	Gate controlled turn-on time	$I_{TM}=6A; V_D=V_{DRM(max)}; I_G=0.1A;$ $dI_G/dt=5A/\mu s$	-	2	-	$\mu s$

### Description

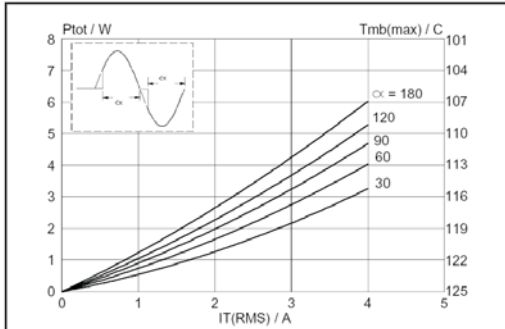

Fig. 1. Maximum on-state dissipation,  $P_{tot}$ , versus rms on-state current,  $I_{T(RMS)}$ , where  $\alpha$  = conduction angle.

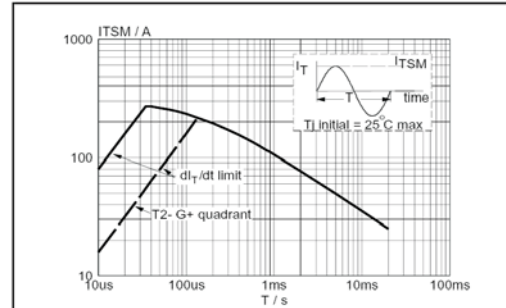

Fig. 2. Maximum permissible non-repetitive peak on-state current  $I_{TSM}$ , versus pulse width  $t_p$ , for sinusoidal currents,  $t_p \leq 20$ ms.

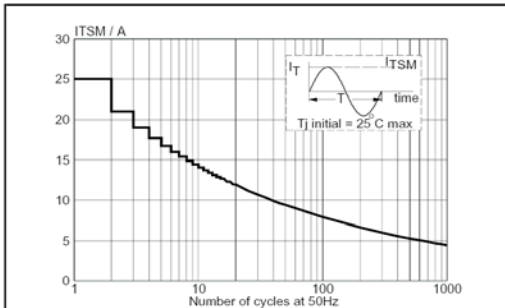

Fig. 3. Maximum permissible non-repetitive peak on-state current  $I_{TSM}$ , versus number of cycles, for sinusoidal currents,  $f = 50$  Hz.

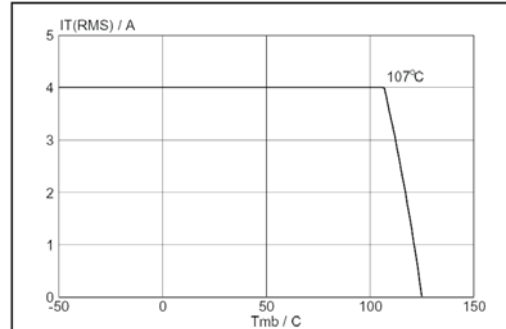

Fig. 4. Maximum permissible rms current  $I_{T(RMS)}$ , versus mounting base temperature  $T_{mb}$ .

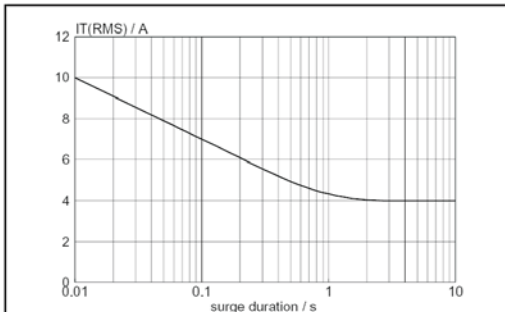

Fig. 5. Maximum permissible repetitive rms on-state current  $I_{T(RMS)}$ , versus surge duration, for sinusoidal currents,  $f = 50$  Hz;  $T_{mb} \leq 107^\circ\text{C}$ .

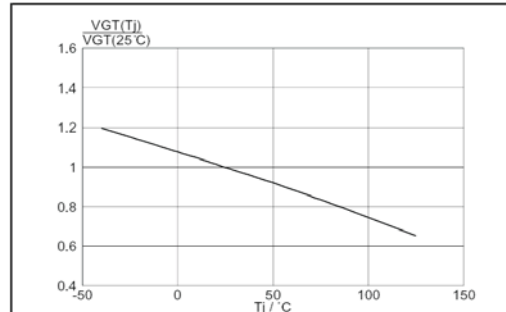
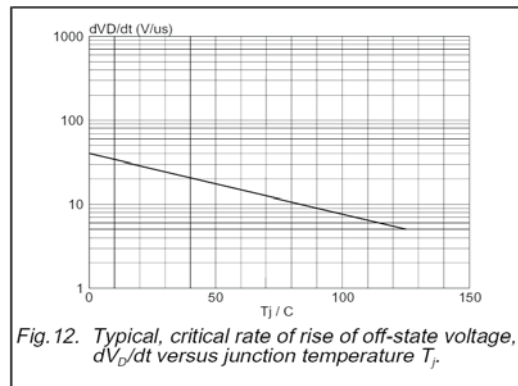
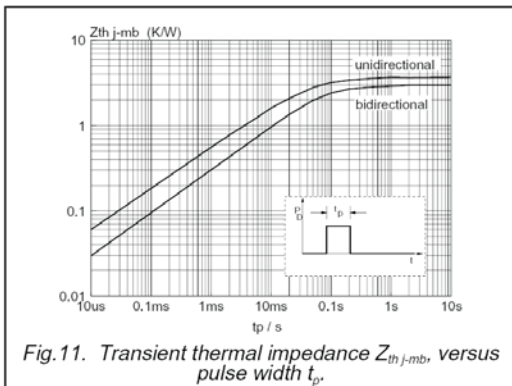
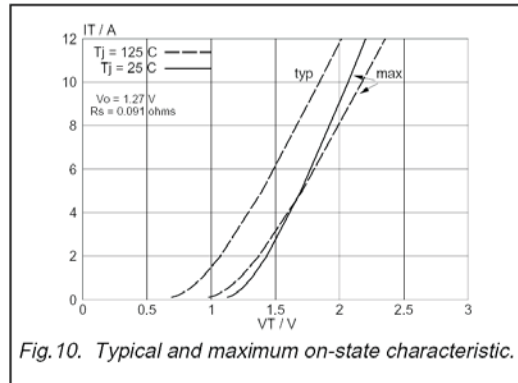
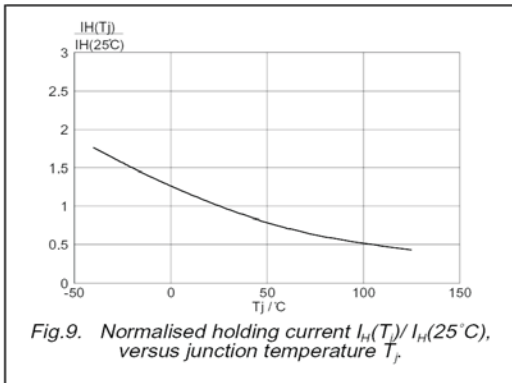
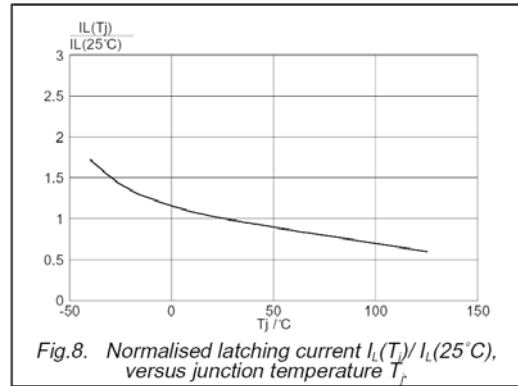
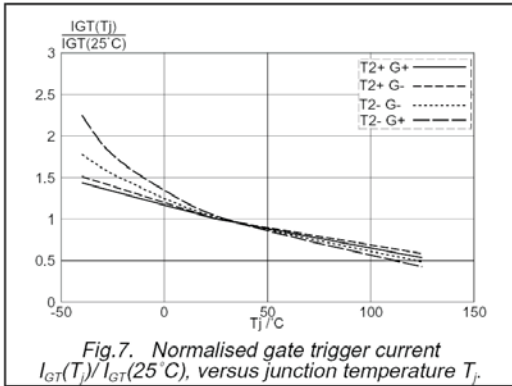

Fig. 6. Normalised gate trigger voltage  $V_{GT}(T_j) / V_{GT}(25^\circ\text{C})$ , versus junction temperature  $T_j$ .

Description



MECHANICAL DATA

Dimensions in mm

Net Mass: 0.8 g

SOT-82

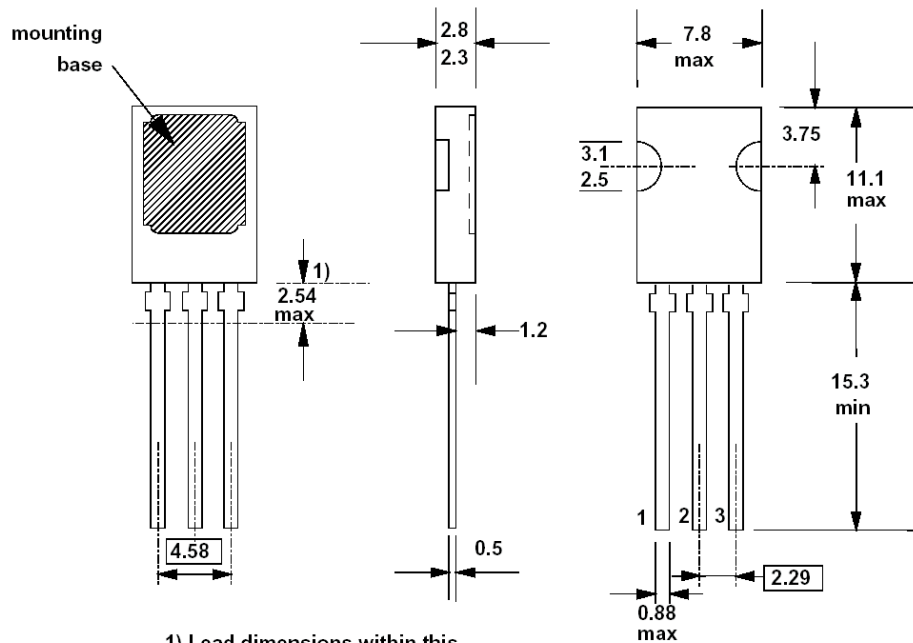

1) Lead dimensions within this zone uncontrolled.