

Features

- 10A switching capability
- Contact arrangement:1A, 1C
- Provide high sensitivity type of products, coil power consumption is 200mW
- Breakdown voltage (between coil and contacts):5KV
- Creepage distance and air distance are greater than10mm
- We can provide the product with ambient temperature is 105°C
- UL insulation system:Class F
- Environmental friendly product(RoHS compliant)
- Outline Dimensions:(18.6×10.3×13.0)mm
- Main application:Industrial control, Smart home, 5G communication power

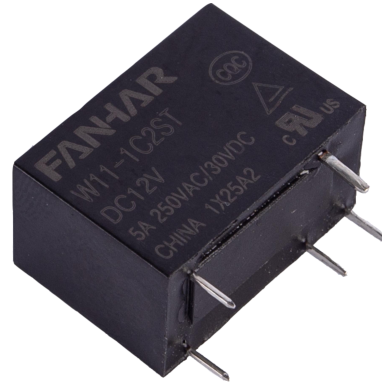

TV-5 C  US

CHARACTERISTICS

Specifications	Item			
Contact Data	Contact arrangement		1A, 1B, 1C	
	Contact resistance(initial)		≤100mΩ(6VDC 1A)	
	Contact material		AgNi, AgSnO ₂	
Rated value	Rated load(Resistance load)		5A 250VAC/30VDC 10A 125VAC 10A 250VAC/30VDC	
	Max.switching voltage		277VAC/30VDC	
	Max.switching current		10A	
	Max.switching capacity		2500VA/300W	
	Min.allowing load		5VDC 100mA	
Electrical performance	Insulation resistance(initial)		1000MΩ(500VDC)	
	Dielectric strength (initial)	Between open contacts	1000VAC, 1 min	
		Between coil&contacts	4000VAC, 1 min	
	Operate time		≤10ms	
	Release time		≤5ms	
Mechanical performance	Shock resistance	Functional	98m/s ² (10G)	
		Destructive	980m/s ² (100G)	
	Vibration resistance		10Hz~55Hz 1.5mm DA	
Endurance	Mechanical		1×10 ⁶ ops	
	Electrical(Room temperature)		3A 250VAC(PF=0.6)	1×10 ⁵ ops(ON/OFF=1s/9s)
			5A 250VAC/30VDC	1×10 ⁵ ops(ON/OFF=1s/9s)
		10A 250VAC/30VDC	5×10 ⁴ ops(ON/OFF=1s/9s)	
Operate condition	Ambient temperature		-40°C~85/105°C	
	Humidity		5% to 90%	
Termination			PCB	
Unit weight			Approx.5g	
Construction			Plastic sealed, Flux proofed	

COIL DATA(23°C)

Standard Type

Nominal Voltage	Operate Voltage VDC	Release Voltage VDC	Rated Current (±10%)	Coil Resistance (±10%)	Nominal Power	Max Voltage
DC 3V	≤2.25	≥0.15	150mA	20Ω	450mW	DC 3.9V
DC 5V	≤3.75	≥0.25	90 mA	55.5Ω		DC 6.5V
DC 6V	≤4.50	≥0.30	75 mA	80Ω		DC 7.8V
DC 9V	≤6.75	≥0.45	50 mA	180Ω		DC 11.7V
DC 12V	≤9.00	≥0.60	37.5 mA	320Ω		DC 15.6V
DC 15V	≤11.25	≥0.75	30 mA	500Ω		DC 19.5V
DC 18V	≤13.50	≥0.90	25 mA	720Ω		DC 23.4V
DC 24V	≤18.00	≥1.20	18.8 mA	1280Ω		DC 31.2V
DC 48V	≤36.00	≥2.40	10.4 mA	4608Ω	500mW	DC 62.4V

Sensitive Type

Nominal Voltage	Operate Voltage VDC	Release Voltage VDC	Rated Current (±10%)	Coil Resistance (±10%)	Nominal Power	Max Voltage
DC 3V	≤2.4	≥0.15	66.7mA	45Ω	200mW	DC 3.9V
DC 5V	≤4.0	≥0.25	40 mA	125Ω		DC 6.5V
DC 6V	≤4.8	≥0.30	33.3mA	180Ω		DC 7.8V
DC 9V	≤7.2	≥0.45	22.2 mA	405Ω		DC 11.7V
DC 12V	≤9.6	≥0.60	16.7mA	720Ω		DC 15.6V
DC 15V	≤12.0	≥0.75	13.3 mA	1128Ω		DC 19.5V
DC 18V	≤14.4	≥0.90	11.1 mA	1620Ω		DC 23.4V
DC 24V	≤19.2	≥1.20	8.3 mA	2880Ω		DC 31.2V

ORDERING INFORMATION

W11 -1A 2 S T L E -XXX DC12V

- ① Type
- ② Contact arrangement(1):1A=1 open contacts, 1B=1 close contacts, 1C=1 switched contacts
- ③ PCB mounting:1=type 1, 2=type 2, 3=type 3, 4=type 4
- ④ Construction(2):Nil=Flux proofed, S=Plastic sealed
- ⑤ Contact material (3):Nil=AgNi, T=AgSnO₂
- ⑥ Coil power:Nil=Standard, L=Sensitive
- ⑦ Load:Nil=Standard load, E=High load(10A, Specifications limited to contact form 1A only)
- ⑧ Customer special code:numbers or letters denote customer's requirements, For example: G=Gold plating
- ⑨ Coil specification:DC3/5/6/9/12/15/18/24/48V

- (1) If need the contact arrangement is 1B, please contact with the salesman to ask for the outline dimensions, wiring diagram and PC board layout.
- (2) When used in clean environment(excluding H₂S, SO₂, NO₂, dust and other pollutants), it is recommended to choose the Flux

proofed type;When used in unclean environment(contain H₂S,SO₂,NO₂,dust and other pollutants), it is recommended to choose the Plastic sealed.

(3) Due to the high surge current of relay connection,we propose to use AgSnO₂ contacts.

OUTLINE DIMENSIONS,WIRING DIAGRAM AND PC BOARD LAYOUT(Unit:mm)

1A1 Outline Dimensions

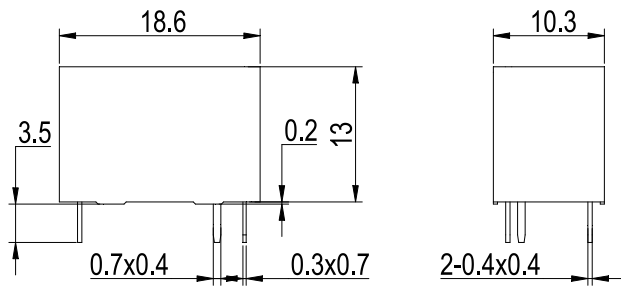

Wiring Diagram
(Bottom view)



PCB Layout
(Bottom view)

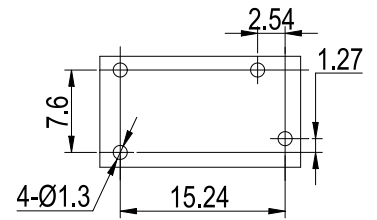

1A2 Outline Dimensions

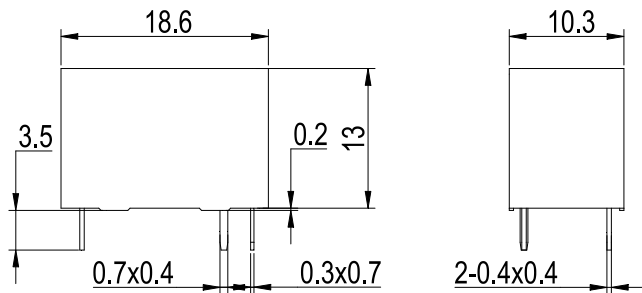

Wiring Diagram
(Bottom view)



PCB Layout
(Bottom view)

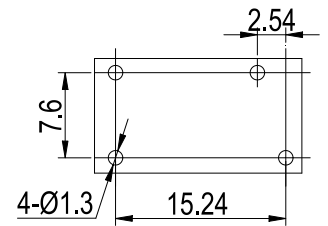

1A3 Outline Dimensions

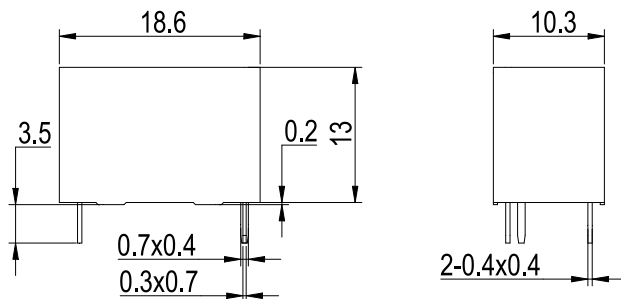

Wiring Diagram
(Bottom view)



PCB Layout
(Bottom view)

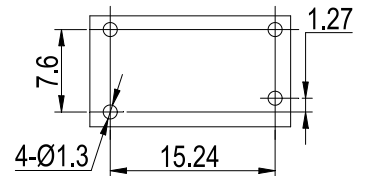

1A4 Outline Dimensions

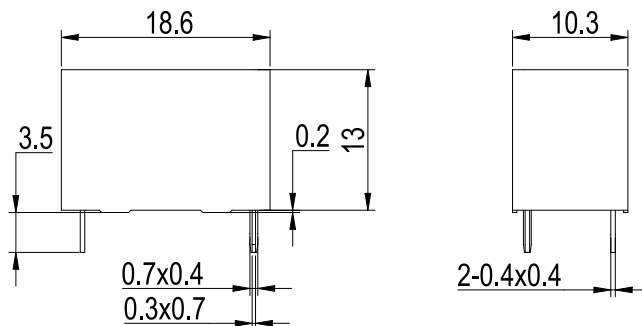

Wiring Diagram
(Bottom view)

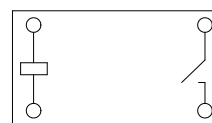

PCB Layout
(Bottom view)

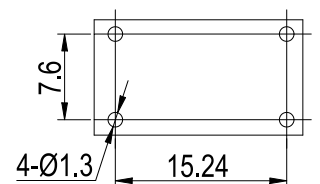

OUTLINE DIMENSIONS, WIRING DIAGRAM AND PC BOARD LAYOUT (Unit:mm)

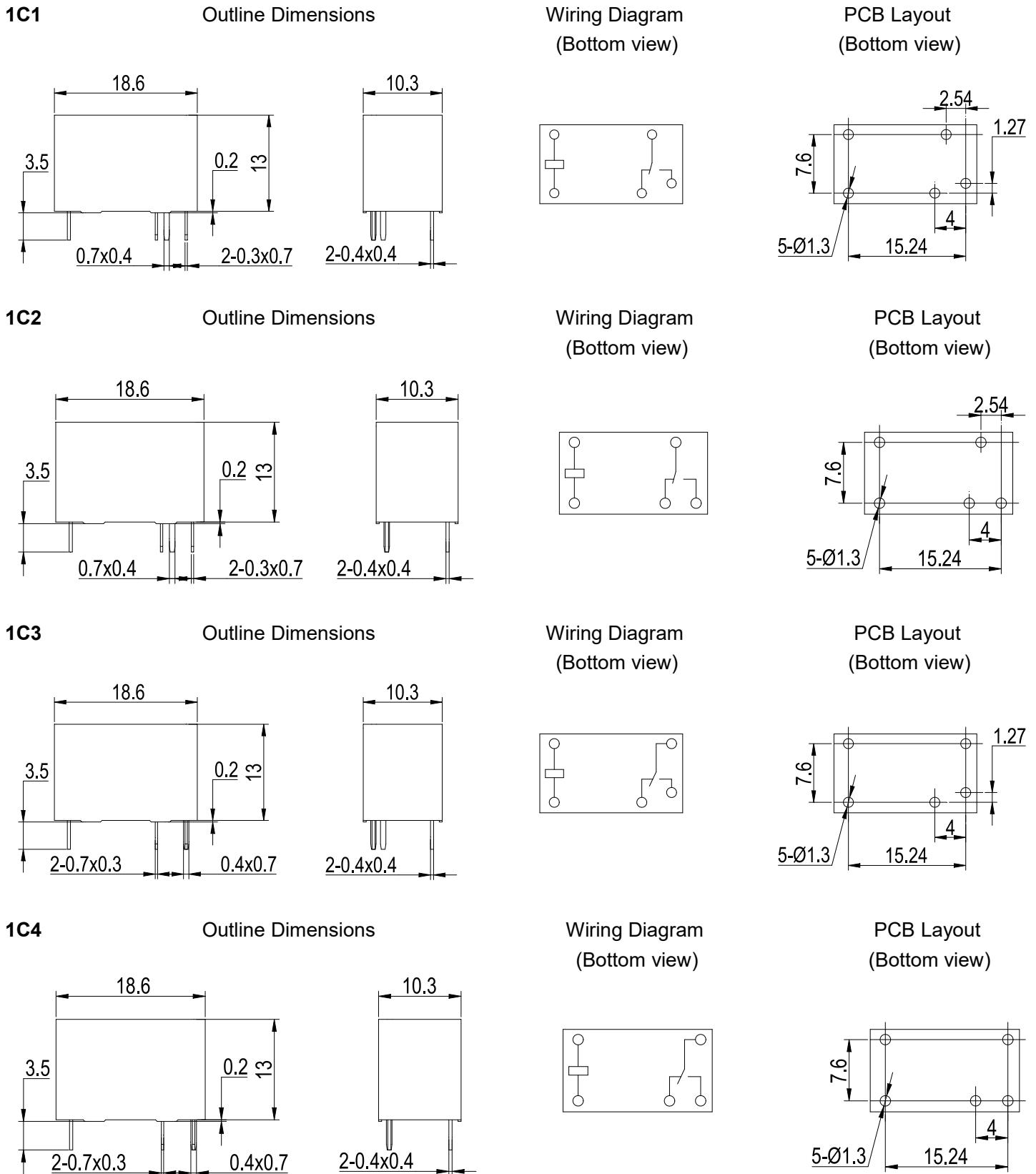

Remark:(1)In case of no tolerance shown in outline dimension:outline dimension \leq 1mm,tolerance should be \pm 0.2mm;outline dimension $>$ 1mm and $<$ 5mm,tolerance should be \pm 0.3mm;outline dimension \geq 5mm,tolerance should be \pm 0.5mm.

(2) The tolerance without indicating for PCB layout is always \pm 0.1mm.

SAFETY APPROVAL RATINGS

Approval	File No.	Contact arrangement	Contact material	Approved ratings				
UL/C-UL	E475405	1A, 1C(NO)	AgNi, AgSnO ₂	10A	250/125VAC/30VDC	85°C		
				1/4HP	250VAC	85°C		
				3A	250VAC (PF=0.6)	85°C		
				1B, 1C(NC)	AgNi, AgSnO ₂	TV-5	125VAC	85°C
						1000W	250VAC(Tungsten)	85°C
						5A	250VAC/30VDC	105°C
TUV	R 50332879	1A, 1C(NO)	AgNi, AgSnO ₂	10A	250VAC/30VDC	85°C		
				5A	250VAC/30VDC	85°C		
		5A		250VAC	105°C			
		1B, 1C(NC)		5A	250VAC/30VDC	85°C		
		1C(NO/NC)		5A/3A	250VAC/30VDC	85°C		
CQC	CQC16002154624	1A, 1C(NO)	AgNi, AgSnO ₂	10A	250VAC/30VDC	85°C		
				5A	250VAC/30VDC	105°C		
		1B, 1C(NC)		5A	250VAC/30VDC	85°C		

PERFORMANCE CURVES

MAXIMUM SWITCHING POWER

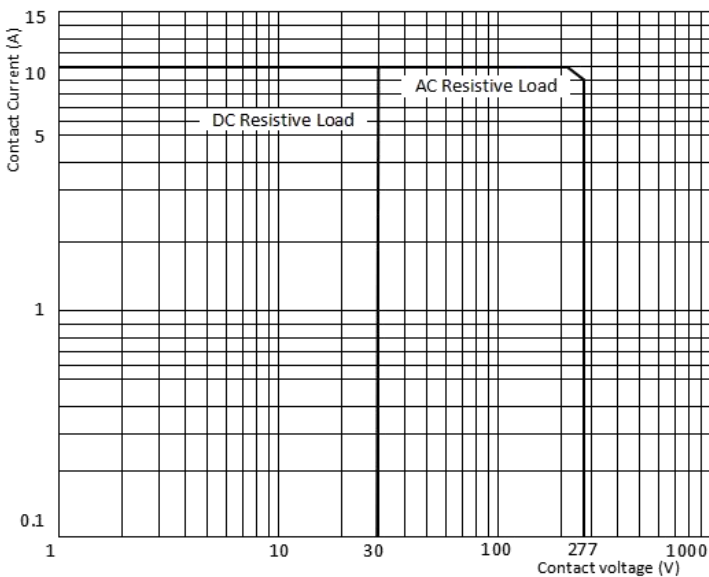

ENDURANCE CURVE

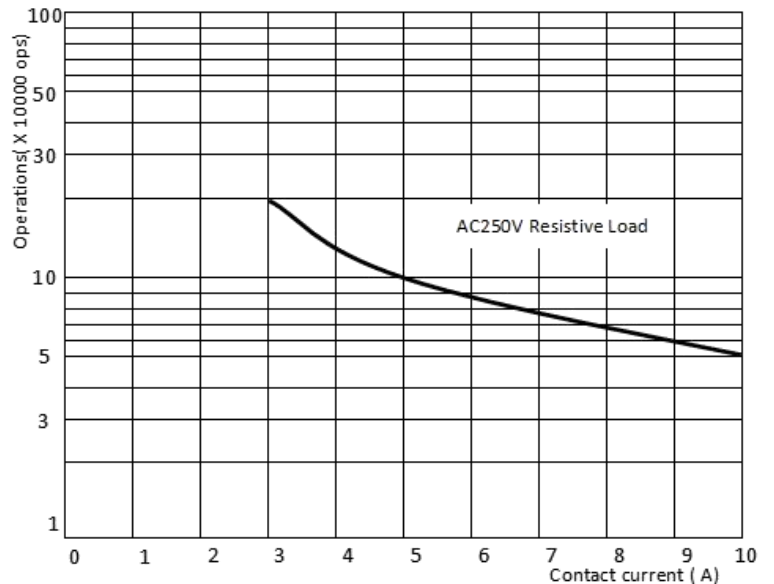

NOTICE

- ① In order to maintain the initial performance parameters of the relay, please be careful not to drop the product;
- ② The specification is for reference only. Specifications subject to change without notice.